

USD

Aquafine Price Book

2021



Please refer to Trojan Technologies Standard Terms and Privacy Policy for important information

[Trojan Technologies Terms](#)

[Trojan Privacy Policy](#)

Customer Information

Trojan Technologies collects and maintains customer information consistent with Trojan's standard terms and privacy policy.

As authorized representatives/resellers of Trojan products, we require your support to maintain customer contact information in accordance with the Trojan Terms and Privacy Policy. This information underlies Trojan's ability to create value and maintain quality, safety and customer satisfaction.

Purchase Order Information

MINIMUM ORDER: 100.00 USD/CAD/EURO/GBP

To help ensure the parts you are ordering are correct please provide us with the project number of the site on the purchase orders.

Discounting

Trojan reserves the right to offer discounts to encourage select customers to purchase parts or to be awarded a contract in the bidding process. In these events, the expectation is the discount is passed along to the customer to ensure the order is secured. When discounts are given, Trojan reserves the right, from time to time, to request a copy of the customer's original PO from our authorized representatives.

Shipping Information

Refer to Trojan's Terms and Conditions of Sale.

All shipping information must be complete on the PO. When shipping to the USA, all PO's sent to Trojan must include both the buyers Federal I.D. number and the "ship to" Federal I.D. number. This is a US Customs requirement. Failure to include this information may cause delays and impact our ability to meet our shared customer's delivery schedule. Refer to the North American Free Trade Agreement (USMCA) requirements for more details.

A handling fee will be charged on all Exworks orders.

Restocking

If a part is ordered incorrectly and needs to be returned to Trojan, a 25% restocking fee, plus shipping/freight, will apply.

Recycling Program

Trojan offers free recycling in select regions on boards, ballasts, and lamps to customers purchasing Trojan Consumables and Replacement Parts ("Genuine" customers). For more information please refer to: <http://www.trojanuv.com/getgenuine> . Consult your local Trojan Representative for options in your region.

Damaged / Missing Item Claims

Damaged and missing item claims must be reported to Trojan Technologies Customer Service within 48 hours upon the receipt of goods.

Repairs

Repairs, excluding Sensor Calibrations and Recertification, will be charged an non-refundable upfront Bench Fee - this fee will only be refunded if a new part is purchased.

Sensor Calibrations/Repairs : Available for select products; serial number and project number are required to confirm requirements.

Senor Re-certification: Available for select products; serial number and project number are required to confirm requirements.

Contact your Account Manager for pricing and lead-time information.

OptiVenn Series

Disinfection/Ozone Models		OPV01CDS	OPV03CDS	OPV02CDM	OPV02DDM	OPV04CDM	OPV04DDM	OPV04CDL	OPV04DDL
Features and Options									
Base Model Price		\$ 5,690	\$ 6,200	\$ 6,900	\$ 7,860	\$ 9,070	\$ 12,120	\$ 14,740	\$ 18,950
Chamber Options	Ra15 Finish*	\$ 1,165	\$ 1,165	\$ 1,165	\$ 1,165	\$ 1,165	\$ 1,165	\$ 1,755	\$ 1,755
	Sanitary Tri-clamp**	\$ 340	\$ 340	\$ 340	\$ 340	\$ 340	\$ 340	\$ 340	\$ 560
	Viton Elastomers***	\$ 590	\$ 590	\$ 590	\$ 800	\$ 590	\$ 800	\$ 590	\$ 800
Control Options	Base Package (includes HOA & LOA)	Included in Base Price							
	UV Intensity Reading with NIST sensor	\$2,990							
Enclosure Options	304 SS, UL Type 1 / IP51, Flat Top	Included in Base Price							
	304 SS, UL Type 12 / IP54, Sloped Top	Not Available							
	304 SS, UL Type 4X / IP 66, Sloped Top	\$2,115							
Validated lamps		\$ 100	\$ 295	\$ 200	\$ 200	\$ 395	\$ 395	\$ 395	\$ 395

Disinfection/Ozone Models		OPV06DDL	OPV08DDL	OPV08EDL	OPV08FDL	OPV08GDL	OPV10GDL	OPV12GDL	OPV12HDL
Features and Options									
Base Model Price		\$ 23,220	\$ 28,430	\$ 32,640	\$ 38,470	\$ 44,730	\$ 46,490	\$ 50,880	\$ 53,980
Chamber Options	Ra15 Finish	\$ 1,755	\$ 1,755	\$ 2,010	\$ 2,010	\$ 2,010	\$ 2,010	\$ 2,010	\$ 2,010
	Sanitary Tri-clamp	\$ 560	\$ 560	\$ 560	\$ 560	\$ 560	\$ 560	\$ 560	\$ 560
	Viton Elastomers*	\$ 800	\$ 800	\$ 800	\$ 800	\$ 800	\$ 800	\$ 800	\$ 800
Control Options	Base Package (includes HOA & LOA)	Included in Base Price							
	UV Intensity Reading with NIST sensor	\$2,990							
Enclosure Options	304 SS, UL Type 1 / IP51, Flat Top	Included in Base Price				Not Available			
	304 SS, UL Type 12 / IP54, Sloped Top	\$2,655				Included in Base Price			
	304 SS, UL Type 4X with fan/shroud, Sloped Top	\$4,790				\$3,710			
	304 SS, UL Type 4X / IP 66 with AC, Sloped Top	\$6,880				\$4,250			
Validated lamps		\$ 590	\$ 785	\$ 785	\$ 785	\$ 785	\$ 980	\$ 1,175	\$ 1,175

* Base models include Ra32 surface finish
 ** Base models include ANSI Flange Connections
 *** Base models include EPDM elastomers

OptiVenn Series

TOC Models		04CTM	06CTM	08DTM	08DTL	10DTL	12DTM	12DTL
Features and Options								
Base Model Price***		\$ 9,675	\$ 13,200	\$ 16,350	\$ 19,500	\$ 20,550	\$ 25,275	\$ 27,375
Chamber	Ra15 Finish	\$ 1,175	\$ 1,175	\$ 1,175	\$ 1,750	\$ 1,750	\$ 1,175	\$ 1,750
Options	Sanitary Tri-clamp	\$ 350	\$ 350	\$ 350	\$ 350	\$ 575	\$ 575	\$ 575
Control	Base Package (includes HOA & LOA)	Included in Base Price						
Options	UV Intensity Reading with NIST sensor	\$3,000						
Enclosure Options	304 SS, UL Type 1 / IP51, Flat Top	Included in Base Price	Included in Base Price			Not Available		
	304 SS, UL Type 12 / IP54, Sloped Top	NA	\$2,650			Included in Base Price		
	304 SS, UL Type 4X with fan/shroud, Sloped Top	NA	\$4,800			\$3,700		
	304 SS, UL Type 4X / IP 66, Sloped Top	\$2,125	\$6,875			\$4,250		
Validated lamps		\$ 375	\$ 600	\$ 800	\$ 800	\$ 1,000	\$ 1,175	\$ 1,175

* Base models include Ra32 surface finish

** Base models include ANSI Flange Connections

*** Base models include Viton elastomers

Aquafine Logic Series (Disinfection/Ozone)

Aquafine Logic Series (Disinfection/Ozone)		03AS20	04AS20	03AL20	06AS20	04AL20	08AS20
Features and Options							
Base Model	Aquafine Logic	\$ 30,000	\$ 33,000	\$ 34,500	\$ 39,000	\$ 41,500	\$ 49,000
Wiper System	Manual	\$ 2,000	\$ 2,000	NA	\$ 2,000	NA	\$ 2,000
Wiper System	Automatic	\$ 6,000	\$ 6,000	\$ 7,000	\$ 6,000	\$ 7,000	\$ 6,000
Cylinder	Air Vent Kit (Vertical Orientation)	\$ 2,500	\$ 2,500	NA	\$ 2,500	NA	\$ 2,500
Enclosure	120V Transformer (External)	\$ 2,500	\$ 2,500	\$ 2,500	\$ 2,500	\$ 2,500	\$ 2,500
Finish	Ra15 Interior Surface	\$ 1,500	\$ 1,500	\$ 1,500	\$ 1,500	\$ 1,500	\$ 1,500
Enclosure	Mild Steel Type 3R	Advise	Advise	Advise	Advise	Advise	Advise
Enclosure	SS304 Type 4X	Advise	Advise	Advise	Advise	Advise	Advise

Aquafine Logic Series (Disinfection/Ozone)		08AL20	06AL30	12AL40	18AL40	18AL50	32AL50
Features and Options							
Base Model	Aquafine Logic	\$ 56,500	\$ 62,000	\$ 102,500	Contact Aquafine for Quote	Contact Aquafine for Quote	Contact Aquafine for Quote
Wiper System	Manual	NA	NA	NA			
Wiper System	Automatic	\$ 7,000	\$ 7,000	\$ 7,000			
Cylinder	Air Vent Kit (Vertical Orientation)	NA	NA	NA			
Enclosure	120V Transformer	\$ 4,000	\$ 2,500	\$ 4,000			
Finish	Ra15 Interior Surface	\$ 2,500	\$ 2,500	\$ 2,500			
Enclosure	Mild Steel Type 3R	Advise	Advise	Advise	Advise	Advise	Advise
Enclosure	SS304 Type 4X	Advise	Advise	Advise	Advise	Advise	Advise

Aquafine Logic Series includes the following in the base model list price:

- Flanged I/O
- Ra32 finish surface
- UV Intensity Meter W/ 4-20mA Interface
- HAND/OFF/AUTO Controls
- Painted Steel Type 12
- Beijer HMI Panel

Optional (No Cost Adder):

- ANSI or DN Flange

**Last Buy Date of 29 Nov, 2019 (Per Bulletin Number AQ09242019)

02AS20, 06AL20, 08AL30, 12AL30

SWIFT BEVERAGE SERIES

SWIFT BEVERAGE SERIES (Disinfection/Ozone)		SBV300	SBV600	SBV1200	SBV1800*
Features and Options					
Base Model	Swift Beverage	\$ 56,400	\$ 68,200	\$ 101,200	\$ 155,800
Wiper System	Automatic	\$ 6,800	\$ 6,800	\$ 8,200	\$ 8,700
Finish	Ra15 Interior Surface	\$ 2,300	\$ 2,300	\$ 3,000	\$ 3,000
Chamber	Outlet Rotation	\$ 2,100	\$ 2,100	\$ 2,100	\$ 2,100
Enclosure	Mild Steel Type 3R	\$ 2,500	\$ 2,500	\$ 3,500	Advise
Enclosure	SS304 Type 4X	\$ 6,300	\$ 6,300	\$ 9,400	Advise
Enclosure	120V Transformer	\$ 3,700	\$ 3,700	\$ 3,700	NA
Other	Optiview UVT Meter	\$ 20,200	\$ 20,200	\$ 20,200	\$ 20,200

* SBV 1800 - Sanitary (Not applicable)

Modbus 485 - Standard

Painted Steel Type 12 (Standard)

Beijer HMI Panel (Standard)

SWIFT BEVERAGE SERIES

SWIFT BEVERAGE - PMO SERIES		SBV300	SBV600	SBV1200	SBV1800
Features and Options					
Base Model	Swift Beverage - PMO	\$ 72,350	\$ 93,600	\$ 143,500	Advise
Wiper System	Automatic	\$ 6,725	\$ 6,725	\$ 8,200	Advise
Finish	Ra15 Interior Surface	\$ 2,250	\$ 2,250	\$ 3,000	Advise
Chamber	Outlet Rotation	\$ 2,050	\$ 2,050	\$ 2,050	Advise
Enclosure	Mild Steel Type 3R	\$ 2,500	\$ 2,500	\$ 3,500	Advise
Enclosure	SS304 Type 4X	\$ 6,225	\$ 6,225	\$ 9,350	Advise
Enclosure	120V Transformer	\$ 3,700	\$ 3,700	\$ 3,700	Advise
Other	Optiview UVT Meter	\$ 20,200	\$ 20,200	\$ 20,200	Advise

Swift Beverage Series includes the following in the base model list price:

- Sanitary I/O, advise for Flange I/O
- Ra32 finish surface
- UV Intensity Meter W/ 4-20mA Interface
- HAND/OFF/AUTO Controls
- SCADA Card
- Type 3R 304 Stainless Steel Control Cabinet

VL Series

VL Series (Disinfection/TOC)				
Features and Options		VL 200	VL 410	VL 410 TOC
System	Base Model	\$ 1,975	\$ 3,225	\$ 3,600
Cylinder	Sanitary I/O	\$ 275	\$ 275	\$ 275
Controls	UV Monitoring NIST	\$ 2,750	\$ 2,750	\$ 2,750









Power Cord Options:		
NA	North America	120VAC
EU	European	230VAC CEE7/7
AUS/NZ	Australia/New Zealand	230VAC AS3112
UK	United Kingdom	230VAC BS1363

VL Series includes the following in the base model list price:

- Flanged I/O
- Viton elastomers (USP Class VI)
- Ra32 finish surface
- Sampling ports
- Digital lamp days remaining timer
- Audible lamp out and fault alarm
- Auxiliary output (LOA)

After Market Parts

VL Series (VL 200, VL 410, VL 410 TOC)

Item	Part Number	Description	Picture	List Price (USD)
UV Lamps	250449-DS12	Single lamp HO Disinfection / Ozone destruction 12" (VL200)		\$ 123.00
	250449-DS20	Single lamp HO Disinfection / Ozone destruction 20" (VL410)		\$ 132.00
	250450-TS20	Single lamp HO TOC / Chlorine 20" (VL410 TOC)		\$ 135.00
Quartz Sleeves	250015-13	Sleeve, Quartz 20x22.8x330mm DE (13")		\$ 90.00
	250015-21	Sleeve, Quartz 20x22.8x540mm DE (21")		\$ 98.00
Controller	210153	Controller, AQ Non-Monitored		\$ 345.00
	210154-M	Controller, AQ Monitored		\$ 575.00
Sensor	270306-AQ	UVIntensity Sensor, AQ - Nist Traceable		\$ 450.00
O-rings	441096-R	O-Ring, Viton		\$ 11.00
Lamp Connector	270276-R	Lamp Connector, VL Series		\$ 12.00
Spring	SP008	Spring, Quartz Sleeve		\$ 5.00
Gland Nut	RN-001	Glad Nut, 1.5"		\$ 12.00
Gland Nut	RN-001/1	Gland Nut with dome plug, 1.5"		\$ 16.00
Power Cords	602636	Power Cord, VL Series, NEMA 5-15P, 120V		\$ 11.00
	602637	Power Cord, VL Series, CEEE 7/7, 230V		\$ 19.00
	260012	Power Cord, VL Series, BS1363, 230V		\$ 19.00
	260013	Power Cord, VL Series, AS3112, 230V		\$ 19.00
Accessory	260134	CABLE, PLUG & SOCKET 4-20mA Y SILVER/COBALT		\$ 223.00
	260135	CABLE, FEMALE IEC SOLENOID		\$ 24.00

After Market Parts

OptiVenn Series

Item	Part Number	Picture	List Price (USD)
UV Lamps	52885-DS15Z	Lamp, HX 5P 15" 254nm STD	\$ 117
	52885-DS30Z	Lamp, HX 5P 30" 254nm STD	\$ 159
	52885-DS30Z-04	Lamp, HX 5P 30" 254nm STD - 4 PACK	\$ 591
	52885-DS30Z-32	Lamp, HX 5P 30" 254nm STD - 32 PACK	\$ 4,588
	52885-DS60Z	Lamp, HX 5P 60" 254nm STD	\$ 238
	52885-DS60Z-04	Lamp, HX 5P 60" 254nm STD - 4 PACK	\$ 889
	52885-DS60Z-32	Lamp, HX 5P 60" 254nm STD - 32 PACK	\$ 6,967
	52885-TS30N	Lamp, HX 5P 30" 185nm STD	\$ 204
	52885-TS30N-04	Lamp, HX 5P 30" 185nm STD - 4 PACK	\$ 787
	52885-TS30N-32	Lamp, HX 5P 30" 185nm STD - 32 PACK	\$ 6,117
	52885-TS60N	Lamp, HX 5P 60" 185nm STD	\$ 272
	52885-TS60N-04	Lamp, HX 5P 60" 185nm STD - 4 PACK	\$ 1,016
	52885-TS60N-32	Lamp, HX 5P 60" 185nm STD - 32 PACK	\$ 7,987
	52885-DV30Z	Lamp, HX 5P 30" 254nm VALIDATED	\$ 254
	52885-DV60Z	Lamp, HX 5P 60" 254nm VALIDATED	\$ 332
52885-TV30N	Lamp, HX 5P 30" 185nm VALIDATED	\$ 293	
52885-TV60N	Lamp, HX 5P 60" 185nm VALIDATED	\$ 362	
52885-TV60S	Lamp, HX 5P 30" 185nm VALIDATED, Synthetic Qtz	\$ 1,122	
52885-TS60S	Lamp, HX 5P 60" 185nm VALIDATED, Synthetic Qtz	\$ 820	
Lamp O-rings	002190-214F	Viton	\$ 26
	002211-214F	EPDM	\$ 16
	002287-214	Viton, white - Class VI	\$ 50
Quartz Sleeves	45074	QTZ SLV 25mmx17" SE	\$ 85
	19882	QTZ SLV 25mmx30" SE	\$ 99
	16791	QTZ SLV 25mmx60" SE	\$ 145
	52838	Sleeve Bolt, nickel plated brass	\$ 76
	52861	Spring	\$ 9
	53439	Viton Sleeve Bolt Washer (Replaces 52843)	\$ 21
53164	EPDM Sleeve Bolt Washer	\$ 42	
Baffle Assembly	002190-111F	O-Ring Viton	\$ 10
	002211-111F	O-Ring EPDM	\$ 7
	19737-4	Teflon BUSHING, 25mm QTZ SPT MACH 14GA	\$ 24
Chamber O-RING - RED CLASS I	52796-114	O-RING, .605 X .102 VITON II	\$ 13
	52796-382	O-RING, 12.832 X .208 VITON II	\$ 361
	52796-384	O-RING, 14.810 X .208 VITON II	\$ 402
	52796-386	O-RING, 16.768 X .208 VITON II	\$ 479
	52796-388	O-RING, 18.746 X .208 VITON II	\$ 541
Chamber Gasket / O-ring Kit	52899-06E	O-RING/GSKT KIT, EPDM Ø6" Chamber OPV	\$ 65
	52899-06C	O-RING/GSKT KIT, VITON White Ø6" Chamber OPV - Class VI	\$ 1,598
	52899-08E	O-RING/GSKT KIT, EPDM Ø8" Chamber OPV	\$ 71
	52899-08V	O-RING/GSKT KIT, VITON Ø8" Chamber OPV	\$ 642
	52899-08C	O-RING/GSKT KIT, VITON White Ø10" Chamber OPV - Class VI	\$ 1,753
	52899-10E	O-RING/GSKT KIT, EPDM Ø10" Chamber OPV (Replaces 16790)	\$ 45
	52899-10V	O-RING/GSKT KIT, VITON Ø10" Chamber OPV (Replaces 40427)	\$ 403
	52899-12E	O-RING/GSKT KIT, EPDM Ø12" Chamber OPV (Replaces 15601)	\$ 51
	52899-12V	O-RING/GSKT KIT, VITON Ø12" Chamber OPV (Replaces 40428)	\$ 338
	52899-14E	O-RING/GSKT KIT, EPDM Ø14" Chamber OPV (Replaces 16063)	\$ 69
	52899-14V	O-RING/GSKT KIT, VITON Ø14" Chamber OPV (Replaces 40429)	\$ 567
	52899-16E	O-RING/GSKT KIT, EPDM Ø16" Chamber OPV (Replaces 42037)	\$ 3
52899-16V	O-RING/GSKT KIT, VITON Ø16" Chamber OPV (Replaces 42339)	\$ 634	

Legend:52885-ABLLN

A Application
D=Disinfection
T=TOC











B Lamp Type
S=Standard Lamp
V=Validated Lamp

LL Lamp Length
15=15inch length
30=30inch length
60=60inch length

N Lamp Material Grade
Z=Ozone Free Quartz
N=Natural Grade Quartz
S=Synthetic Grade Quartz

After Market Parts

OptiVenn Series

Item	Part Number		Picture	List Price (USD)
Cooling Fan	52912-BTHR	FAN, 4" AXIAL 100-240V 124 CFM		\$ 76
	53327	FAN, 2" AXIAL 100-240V 56 CFM		\$ 101
	916850-3237066	FAN, FILTER MAT 5"X5" EMC for CE(Qty 5) (Used with 2" Fan)		\$ 577
	916850-3321700	FAN, FILTER MAT 5"X5" STD for UL (Qty 5)(Used with 2" Fan)		\$ 176
	916850-3238066	FAN, FILTER MAT 6"X6" EMC for CE(Qty 5) (Used with 4" Fan)		\$ 778
	916850-3322700	FAN, FILTER MAT 6"X6" STD for UL (Qty 5) (Used with 4" Fan)		\$ 150
Lamp Connection	17489-8	Lamp cap with hole		\$ 19
	52819-3-600-99-105	Lamp Socket 9 feet, 9inches 105 DEG (Replaces 52819-5-600-)		\$ 65
	52819-3-600-22-105	Lamp Socket 22 feet, 105DEG (Replaces 52819-5-600-)		\$ 101
	52819-5-300-11-080	Lamp Socket 11 feet, 80DEG		83
	52819-5-300-22-080	Lamp Socket 22 feet, 80DEG		\$ 140
Boards and Controls	50667-MMMMM-B	Base Board for Model MMMMM		\$ 1,299
	50667-MMMMM-U	UV Monitoring Board for Model MMMMM		\$ 1,404
		<i>Example - Base board for model OPV04DDM = 50667-04DDM-B</i>		
	50757-3	Universal Controller membrane (Replaces 50757-1, 50757-2)		\$ 37
	50770-1	Ribbon Cable 16" Long		\$ 64
50666	LCD Display		\$ 385	
UV Instensity (UVI) Sensor	015538-001CERT	SENSOR ASSY, OPTIVENN - NIST		\$ 3,000
	52863-V	Sensor Port Plug Kit, Viton (For systems without UVI sensor)		\$ 232
	52863-E	Sensor Port Plug Kit, EPDM (For systems without UVI sensor)		\$ 258













After Market Parts

OptiVenn Series

Item	Part Number		Picture	List Price (USD)	
UV Instensity (UVI) Sensor	52856-110	HARNES ASSY, SNSR OPTIVENN 11 FT		\$ 183	
	52856-220	HARNES ASSY, SNSR OPTIVENN 22 FT		\$ 204	
Lamp Driver	43474-3	Electronic ballast 120/240 V (replaces 43474-1, except use with 15" UV Lamp)		\$ 752	
	43474-1	Electronic ballast 120/240 V 15" UV Lamp only		\$ 752	
Temperature Sensor	52855	Temperature Switch		\$ 112	
Limit Switch	793851	End Cap Limit Switch		\$ 56	
Port Plugs - UV Chamber Sanitary Ferrule Option	793643-001	End Cap, Ferrule		\$ 27	
	820693-001	Gasket, 1/2" & 3/4" Viton		\$ 15	
	793644-001	Gasket, 1/2" & 3/4" EPDM		\$ 11	
	791195	CLAMP, 1/2" & 3/4" SANITARY		\$ 26	
	793643-002	End Cap, Ferrule		\$ 32	
	820693-002	Gasket, 1 1/2" Viton		\$ 19	
	793644-002	Gasket, 1 1/2" EPDM		\$ 13	
	40234	CLAMP, 1" SANITARY		\$ 60	
	Drain Port Plug	907782-0422316	Drain Port Plug - PIPE PLUG, NPT 1/4" HH S 316		\$ 26
		907782-0622316	Drain Port Plug - PIPE PLUG, NPT 3/8" HHS 316		\$ 47
907782-0822316		Drain Port Plug - PIPE PLUG, NPT 1/2" HHS 316	\$ 47		
Operator Kit	52929	Operator Kit		\$ 773	
	52917	Sleeve Bolt removal tool		\$ 191	
	52923	Sleeve Removal tool,25mm		\$ 479	









After Market Parts

LS, LSHX

Item	Part Number	Description	Picture	List Price (USD)
Lamps	Gold-S	Single lamp Disinfection / Ozone destruction 30" (LSHX)		\$ 156
	Gold-S4	4-pack lamps Disinfection / Ozone destruction 30" (LSHX)		\$ 578
	Gold-S32	32-pack lamps Disinfection / Ozone destruction 30" (LSHX)		\$ 4,508
	Gold-L	Single lamp Disinfection / Ozone destruction 60" (LSHX)		\$ 232
	Gold-L4	4-pack lamps Disinfection / Ozone destruction 60" (LSHX)		\$ 870
	Gold-L32	32-pack lamps Disinfection / Ozone destruction 60" (LSHX)		\$ 6,814
	Cream-S	Single lamp Validated Disinfection / Ozone destruction 30" (LSHX)		\$ 248
	Cream-L	Single lamp Validated Disinfection / Ozone destruction 60" (LSHX)		\$ 326
	3084LM	Disinfection / Ozone destruction 30" (LS)		\$ 106
	3098LM	Disinfection / Ozone destruction 60" (LS)		\$ 141
	16676	Validated Disinfection / Ozone destruction 30" (LS)		\$ 193
	16677	Validated Disinfection / Ozone destruction 60" (LS)		\$ 265
	Quartz Sleeves	45034	25mm X 15" DE	
3184		25mm X 30" DE		\$ 101
3198		25mm X 60" DE		\$ 149
Quartz Sleeves O-rings	40413	Viton		\$ 12
	40416	O-RING 2-015 VITON RED		\$ 11
Bumper (spacer)	4255	EPDM 25mm	NA	\$ 10
	40420	Viton 25mm	NA	\$ 62
For Electro Magnetic Ballast retrofit kits reference 'Retrofit Parts' page				
Ballast	43474-3	Electronic ballast 120/240 V (Replaces 43474-1)		\$ 752
	45040	Electronic ballast 120/240 V - Mini models		\$ 396
	19221-6	3 pin ballast connector assembly (For ballast 43474-3)		\$ 63
	40331-6	4 pin ballast connector assembly (For ballast 43474-3)		\$ 70
Fan	44717	4" fan 24VDC 200 cfm		\$ 153
	41903	4" fan 24VDC, 100cfm		\$ 199
	3901	4" fan120 VAC		\$ 130
	3903	4" fan 240 VAC		\$ 118









After Market Parts

LS, LSHX

Item	Part Number	Description	Picture	List Price (USD)
	40357-2	Compression Nut Stainless Steel 25mm		\$ 193
	17489-1	Compression Nut cap without hole		\$ 21
	17489-3	Compression Nut cap without hole no knurl		\$ 31
	47520-3	Lamp Socket kit 8ft		\$ 73
	47387-8	Lamp Socket SE 8 ft.		\$ 55
Compression Nuts and Lamp Sockets	47597	Wave Spring (Replaces 47518)		\$ 6
	17489-6	Lamp cap with hole (used with lamp socket 47387)		\$ 28
	47520-5	Lamp Socket kit 16ft		\$ 81
	47387-16	Lamp Socket SE 16 ft.		\$ 63
	47597	Wave Spring (Replaces 47518)		\$ 6
	17489-6	Lamp cap with hole (used with lamp socket 47387)		\$ 28









After Market Parts

LS, LSHX

Item	Part Number	Description	Picture	List Price (USD)
	16184	DE lamp Socket 2 ft		\$ 28
Compression Nuts and Lamp Sockets	16184-1	DE lamp Socket 8 ft		\$ 40
	53399	SE Compression Nut Wrench (replaces 18517)		\$ 29
	51049	SE Compression Nut Tool		\$ 205
	43240-1	Assembly Kit Detector		\$ 1,652
	42601	X-254 Detector		\$ 1,466
	41116	20 ft. Cable for X-254		\$ 213
UV Instensity (UVI) Sensor	43240	Assembly Kit Detector with NIST Cerificate		\$ 2,506
	43055	NIST Certificate for 42601		\$ 854
	42601	X-254 Detector		\$ 1,466
	41116	20 ft. Cable for X-254		\$ 213









After Market Parts

LS, LSHX

Item	Part Number	Description	Picture	List Price (USD)
	48425	X-254 UV/Temperature Hermetically Sealed Detector		\$ 2,322
	16956	Sensor Port Plug		\$ 123
	40432	O-ring Viton		\$ 14
	16881	O-ring EPDM		\$ 10
	41116	20 ft. Cable for X-254		\$ 213
UV Instensity (UVI) Sensor	18176-1	S-254 PROBE ASY 360 DEG		\$ 1,219
	40246	Retro sensor window kit S-254 360 adapter		\$ 393
	40007	sensor quartz high hat		\$ 205
	40535	flat fiber washer		\$ 7
	40008-1	short sensor spacer		\$ 228
	40432	sensor o ring Viton		\$ 14

After Market Parts

LS, LSHX

Item	Part Number	Description	Picture	List Price (USD)
UV Instensity (UVI) Sensor	16571	Top Mount UV sensor		\$ 1,382
	4252	Compression Nut		\$ 25
	13898	coax cable assembly 5 ft.		\$ 62
	14150	coax cable assembly 15 ft.		\$ 77
Temperature Sensor (T-120)	792947-1	Surface mount temperature switch only		\$ 100
	17405	Thermistor retro kit		\$ 987
	16958	Thermistor control board (T-120)		\$ 674
	16957	Thermistor		\$ 350
	4055	swagelok		\$ 96





After Market Parts

LS, LSHX

Item	Part Number	Description	Picture	List Price (USD)
	51279-12N	G400 controller with software - 12 lamp - no detector		\$ 4,558
	51279-24N	G400 controller with software - 24 lamp - no detector		\$ 4,558
	51279-36N	G400 controller with software - 36 lamp - no detector		\$ 4,558
	51279-12D	G400 controller with software - 12 lamp - with detector enabled		\$ 4,558
	51279-24D	G400 controller with software - 24 lamp - with detector enabled		\$ 4,558
	51279-36D	G400 controller with software - 36 lamp - with detector enabled		\$ 4,558
	41797-2	MUX Board for HE/HX electronic ballast (2-12 lamp)		\$ 1,585
	41963	MUX board HE/HX electronic ballast (16-44 lamp)		\$ 1,419
Boards and Controls	42119	4-20mA analog module		\$ 1,107
	48446	Expansion Mod w 1m Cable		\$ 299
	48447	Cable, I/O expansion, 2M		\$ 186
	41991	Power supply 24VDC 60W		\$ 337
	42449	Power supply 24VDC 100W		\$ 870
	43074	Signal Cond for detector 24V/5V		\$ 343
	43011-7	PCB ASY LOA 110V 12 LMP		\$ 956
	43011-14	PCB ASY LOA 220V 12 LMP		\$ 956
	43011-21	PCB ASY LOA 120V HE 12LMP		\$ 984
Boards and Controls	43011-28	PCB ASY LOA 220V HE 12LMP		\$ 984
	15843	METER, RTM 118/60 SQ MT		
	15844	METER, RTM 220/50 SQ MT		\$ 148
	17745	METER, RTM 236/60 SQ MT		\$ 136
	40337-12	PC ASSY LED HE 12 120/240		\$ 408
Boards and Controls	17890	LED asy (12 lamp std lamp)		\$ 441
	16460	Lexan (up to 12 lamp)		\$ 28











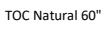
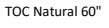
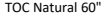
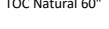
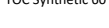
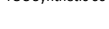







After Market Parts

LS, LSHX

Item	Part Number	Description	Picture	List Price (USD)
	41114-2	X-254 Monitoring Station (UV/Temp)		\$ 1,549.0
Boards and Controls	\$ 41,817.0	Snubber		\$ 21.0
	41114-1	X-254 Monitoring Station (UV/Temp)		\$ 1,457.0
	19747-4	Meter Assembly S-254 controller(vertical mt) 120V		\$ 1,098
	19747-10	Meter Assembly S-254 controller (vertical mt) 120V w 4-20mA		\$ 1,314
Boards and Controls	19747-5	Meter Assembly S-254 controller (vertical mt) 240V		\$ 1,098
	19747-11	Meter Assembly S-254 controller (vertical mt) 240V w 4-20mA		\$ 1,314
	3118	EPDM 6" treatment chamber gasket		\$ 23
End Plate Gaskets	16673	Viton 6" treatment chamber gasket		\$ 243
	12131	Silicone 6" treatment chamber gasket		\$ 179

After Market Parts

Avant Series

Item	Part Number	Description	Picture	List Price (USD)
Lamps	52885-TS60N	Lamp, HX 5P 60" 185nm STD		\$ 272
	52885-TS60N-04	Lamp, HX 5P 60" 185nm STD - 4 PACK		\$ 1,016
	52885-TS60N-32	Lamp, HX 5P 60" 185nm STD - 32 PACK		\$ 7,987
	52885-TV60N	Lamp, HX 5P 60" 185nm VALIDATED		\$ 362
	52885-TS60S	High Performance Lamp, HX 5P 60" 185nm		\$ 820
	52885-TS60S-04	High Performance Lamp, HX 5P 60" 185nm- 4 PACK		\$ 3,082
	52885-TS60S-32	High Performance Lamp, HX 5P 60" 185nm- 32 PACK		\$ 23,606
	52885-TV60S	High Performance Lamp, HX 5P 60" 185nm VALIDATED		\$ 1,122
Sleeves	52994-N	SLEEVE KIT, 60" NATURAL QTZ		\$ 186
	52994-S	SLEEVE KIT, 60" SYNTHETIC QTZ		\$ 670
	53439	Cushion washer, 25MM SLEEVE (Replaces 52843)		\$ 21
	002190-214F	O-RING, 1-1/4 X 1/8 VITON (Replaces 002190-215F)		\$ 26
	52861	Spring (Replaces 796054)		\$ 9
Compression Nuts and Lamp Sockets	17489-8	Lamp cap with hole		\$ 19
	52819-4-300-11-080	Lamp Socket 11 feet (Replaces 52819-5-300-11-080)		\$ 51
	52819-4-300-22-080	Lamp Socket 22 feet (52819-5-300-22-080)		\$ 101
	52838	Sleeve Bolt		\$ 76
	53439	Cushion washer, 25MM SLEEVE (Replaces 52843)		\$ 21
End Plate/Chamber O-ring	52796-382	O-RING, 12.832 X .208 VITON II (Avant 20)		\$ 361
	52796-384	O-RING, 14.810 X .208 VITON II (Avant 36)		\$ 402
	52796-386	O-RING, 16.768 X .208 VITON II (Avant 44)		\$ 479
	52796-388	O-RING, 18.746 X .208 VITON II (Avant 48)		\$ 541
Baffle Assembly	52796-114	O-Ring, .605 X .102 Viton II		\$ 13
	19737-4	Teflon BUSHING, 25mm QTZ SPT MACH 14GA		\$ 24















Legend:52885-ABLLN

- A Application**
 - D=Disinfection
 - T=TOC
- B Lamp Type**
 - S=Standard Lamp
 - V=Validated Lamp
- LL Lamp Length**
 - 15=15inch length
 - 30=30inch length
 - 60=60inch length
- N Lamp Material Grade**
 - Z=Ozone Free Quarts
 - N=Natural Grade Quartz
 - S=Synthetic Grade Quartz

After Market Parts



Avant Series

Legend:52885-ABLLN

Item	Part Number	Description	Picture	List Price (USD)
	015538-003CERT	SENSOR ASSY, NIST AVT (Replaces 015538-002)		\$ 382
UV Instensity (UVI) Sensor	52863-V	Sensor Port Plug Kit, Viton (For systems without UVI sensor)		\$ 232
	52856-110	HARNESS ASSY, SNSR OPTIVENN 11 FT		\$ 183
	52856-220	HARNESS ASSY, SNSR OPTIVENN 22 FT		\$ 204
	002190-014F	O-RING, 1/2 X 1/16 VITON		\$ 47
	52855	Temperature Switch Kit		\$ 112
	792947	Surface mount temperature switch only		\$ 83
	907797-4NBS316	Pressure Relief VALVE, BLEED 1/4" MNPT 316		\$ 979
UV Chamber Components	917626-RLVASSY	Safety Switch Assembly (Limit Switch)		\$ 335
	52827	Temperature Switch Kit 140F		\$ 103
	53201	Temperature Switch 140F		\$ 26
	916850-3244100	FAN, 230VAC 412/453CFM RITTAL		\$ 1,314
Cooling Fan / Air Filter	916850-3243200	FAN, FILTER ASSY 13"X13"RITTAL		\$ 490
	52984-101001	FILTER, AIR 10"X10"X1"		\$ 37
	53225-007	PLC, HMI SIE KTP700 BASIC		\$ 6,670
	916218-102	RS485 Module		\$ 294
Control Board and Software	916217-002	Analog Module		\$ 1,200
	917615	DO Module		\$ 531
	91716-001	PILOT LIGHT, 24V LED RED ABB		\$ 20
	91716-002	PILOT LIGHT, 24V LED GRN ABB		\$ 20
	91716-003	PILOT LIGHT, 24V LED YLW ABB		\$ 20
Lamp Driver	53126	UV Lamp Driver (Replaces 56126)		\$ 1,391
	52929	Operator Kit		\$ 773
Operator Kit	52917	Sleeve Bolt removal tool		\$ 191
	52923	Sleeve Removal tool,25mm		\$ 479

After Market Parts

CSL Plus, CSL HE, Marine CSL Series

Item	Part Number	Description	Picture	List Price (USD)
	17491LM	Single lamp SE Disinfection / Ozone destruction 30"		\$ 131
	17491LM-4	4-pack lamps SE Disinfection / Ozone destruction 30"		\$ 486
	17491LM-32	32-pack lamps SE Disinfection / Ozone destruction 30"		\$ 3,529
	17998LM	Single lamp SE Disinfection / Ozone destruction 60"		\$ 170
	17998LM-4	4-pack lamps SE Disinfection / Ozone destruction 60"		\$ 634
	17998LM-32	32-pack lamps SE Disinfection / Ozone destruction 60"		\$ 4,682
	18059	Single lamp SE Validated Disinfection / Ozone destruction 30"		\$ 204
	18060	Single lamp SE Validated Disinfection / Ozone destruction 60"		\$ 277
	18063	Single lamp SE TOC / Chlorine 30"		\$ 134
	18063-4	4-pack lamps SE TOC / Chlorine 30"		\$ 508
	18063-32	32-pack lamps SE TOC / Chlorine 30"		\$ 3,250
	17498	Single lamp SE TOC / Chlorine 60"		\$ 191
	17498-4	4-pack lamps SE TOC / Chlorine 60"		\$ 726
	17498-32	32-pack lamps SE TOC / Chlorine 60"		\$ 4,508
	18197	Single lamp SE TOC / Chlorine 30"		\$ 255
	18197-64	Bulk Price (+64 count) - Single lamp SE TOC / Chlorine 30"		\$ 194
	18952	Single lamp SE Validated TOC / Chlorine 30"		\$ 342
	17820	Single lamp SE TOC / Chlorine 60"		\$ 294
UV Lamps	17820-64	Bulk Price (+64 count) - Single lamp SE TOC / Chlorine 60"		\$ 219
	18953	Single lamp SE Validated TOC / Chlorine 60"		\$ 342
	18062	Single lamp SE Validated TOC / Chlorine 30"		\$ 253
	18061	Single lamp SE Validated TOC / Chlorine 60"		\$ 361
	3084LM	Standard Double Ended (DE) Disinfection / Ozone destruction 30"		\$ 106
	3098LM	Standard DE Disinfection / Ozone destruction 60"		\$ 141
	3087	Standard DE TOC/Chlorine 30"		\$ 129
	3095	Standard DE TOC/Chlorine 60"		\$ 182
	16676	Standard DE Validated Disinfection / Ozone destruction 30"		\$ 193
	16677	Standard DE Validated Disinfection / Ozone destruction 60"		\$ 265













After Market Parts

CSL Plus, CSL HE, Marine CSL Series

Item	Part Number	Description	Picture	List Price (USD)
UV Lamps	3087	Standard DE TOC / Chlorine 30"		\$ 129
	3095	Standard DE TOC / Chlorine 60"		\$ 182
	16678	DE Validated TOC / Chlorine 30"		\$ 239
	16679	DE Validated TOC / Chlorine 60"		\$ 340
Quartz Sleeves	3184	25mm X 30" DE		\$ 101
	3198	25mm X 60" DE		\$ 149
	18347	22.5mm X 30" DE		\$ 101
	18348	22.5mm X 60" DE		\$ 150
Compression Nuts and Lamp Sockets	18468	SE Compression nut Stainless steel 22.5mm		\$ 193
	40357	Compression Nut Stainless Steel 25mm		\$ 193
	17489-1	Compression Nut cap without hole		\$ 21
	47520-3	Lamp Socket kit 8ft		\$ 73
	47387-8	Lamp Socket SE 8 ft.		\$ 55
	47597	Wave Spring (Replaces 47518)		\$ 6
	17489-5	Lamp cap with hole (used with lamp socket 47387)		\$ 21













After Market Parts

CSL Plus, CSL HE, Marine CSL Series

Item	Part Number	Description	Picture	List Price (USD)
	47520-5	Lamp Socket kit 16ft		\$ 81
	47387-16	Lamp Socket SE 16 ft.		\$ 63
	47597	Wave Spring (Replaces 47518)		\$ 6
	17489-5	Lamp cap with hole (used with lamp socket 47387)		\$ 21
	51049	SE Compression Nut Tool		\$ 205
	13899	Socket Lok Asy(5 pcs)		
Compression Nuts and Lamp Sockets	12423	Spring		\$ 11
	12421	Large cap (spring side)		\$ 21
	12420	Small cap		\$ 20
	12422	DE Compression Nut, CPVC 25mm (qty 2 in kit)		\$ 30
	16184	DE lamp Socket 2 ft		\$ 28
	16184-1	DE lamp Socket 8 ft		\$ 40
	4252	DE Compression Nut,CPVC 25mm		\$ 25
	16898	DE Compression Nut, Stainless steel 25mm		\$ 193
3105	DE Compression Nut wrench		\$ 99	



















After Market Parts

CSL Plus, CSL HE, Marine CSL Series

Item	Part Number	Description	Picture	List Price (USD)
For Electro Magnetic Ballast retrofit kits reference 'Retrofit Parts' page				
Ballast	16518-3	Electronic ballast 120/240 V (Rpelace 16518-1)		\$ 278
	16519	5 pin ballast connector assembly (For ballast 16518-3)		\$ 47
	43474-3	Electronic ballast 120/240 V (For CSL HE) (Replace 43474-1)		\$ 752
	19221-6	3 pin ballast connector assembly (For ballast 43474-3)		\$ 63
	40331-6	4 pin ballast connector assembly (For ballast 43474-3)		\$ 70
Quartz Sleeves O-rings	40413	Viton		\$ 12
	4253	EPDM		\$ 11
	12967	Silicon		\$ 11
	16600	Chemraz		\$ 431
Bumper (spacer)	4255	EPDM 25mm		\$ 10
	40420	Viton 25mm		\$ 62
	40364	EPDM 22.5mm		\$ 14
	40419	Viton 22.5mm		\$ 13
End Plate Gaskets	3118	EPDM 6" treatment chamber gasket		\$ 23
	16673	Viton 6" treatment chamber gasket		\$ 243
	12131	Silicone 6" treatment chamber gasket		\$ 179
	3244	EPDM 8" treatment chamber gasket		\$ 64
	16674	Viton 8" treatment chamber gasket		\$ 778
	12132	Silicone 8" treatment chamber gasket		\$ 392
Fan	3901	4" fan120 VAC		\$ 130
	3903	4" fan 240 VAC		\$ 118







After Market Parts

CSL Plus, CSL HE, Marine CSL Series

Item	Part Number	Description	Picture	List Price (USD)
	18176-1	S-254 UV Intensity Sensor (1-12 lamp - 360 DEG)		\$ 1,219
	40246	Sensor Window Kit		\$ 393
	16571	Top Mount UV Intensity Sensor S-254		\$ 1,382
	4252	Compression nut S-254		\$ 25
	12889	S-254 Port Plug Assembly		\$ 105
	13898	Coax cable assembly 5 ft		\$ 62
	14150	Coax cable assembly 15 ft		\$ 77
	43240-1	Assembly Kit Detector		\$ 1,652
UV Intensity (UVI) Sensor	42601	X-254 Detector		\$ 1,466
	41116	20 ft. Cable for X-254		\$ 213
	43240	Assembly Kit Detector with NIST Certificate		\$ 2,506
	43055	NIST Certificate for 42601		\$ 854
	42601	X-254 Detector		\$ 1,466
	41116	20 ft. Cable for X-254		\$ 213
	48425	X-254 UV/Temperature Hermetically Sealed Detector		\$ 2,322
	16956	Sensor Port Plug		\$ 123
	12889	PLUG ASS'Y., S-254 PORT		\$ 105
	40432	O-ring Viton		\$ 14
16881	O-ring EPDM		\$ 10	
	41116	20 ft. Cable for X-254		\$ 213









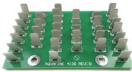

After Market Parts

CSL Plus, CSL HE, Marine CSL Series

Item	Part Number	Description	Picture	List Price (USD)
Temperature Sensor (T-120)	16957	Thermistor (requires swagelok) - for control boards and Aqualogic		\$ 350
	17405	Thermister Retro Kit		\$ 987
	19537	Swagelok 3/8 NPTx3/16" (for thermistor)		\$ 160
	4055	Swagelok 1/4 NPTx3/16" (for thermistor)		\$ 96
	792947-1	Surface mount temperature switch only		\$ 100
Boards and Controls	51279-4B	4 lamp Base		\$ 1,044
	51279-4R	4 lamp Remote		\$ 1,416
	51279-4M	4 lamp Monitoring		\$ 1,531
	51279-6B	6 lamp Base		\$ 1,044
	51279-6R	6 lamp Remote		\$ 1,416
	51279-6M	6 lamp Monitoring		\$ 1,531
	51279-6B	6 lamp Base		\$ 1,044
	51279-6R	6 lamp Remote		\$ 1,416
	51279-6M	6 lamp Monitoring		\$ 1,531
	51279-8B	8 lamp Base		\$ 1,044
	51279-8R	8 lamp Remote		\$ 1,416
	51279-8M	8 lamp Monitoring	\$ 1,531	
	51279-10B	10 lamp Base	\$ 1,044	
	51279-10R	10 lamp Remote	\$ 1,416	
	51279-10M	10 lamp Monitoring	\$ 1,531	
	51279-12B	12 lamp Base	\$ 1,044	
	51279-12R	12 lamp Remote	\$ 1,416	
51279-12M	12 lamp Monitoring	\$ 1,531		











After Market Parts

CSL Plus, CSL HE, Marine CSL Series

Item	Part Number	Description	Picture	List Price (USD)	
	43011-3	PCB ASY LOA 110V 4 LMP		\$ 956	
	43011-4	PCB ASY LOA 110V 6 LMP		\$ 956	
	43011-5	PCB ASY LOA 110V 8 LP		\$ 956	
	43011-6	PCB ASY LOA 110V 10 LP		\$ 956	
	43011-7	PCB ASY LOA 110V 12 LMP		\$ 956	
	43011-10	LOA PC Asy STD 4 lamp 240V		\$ 956	
	43011-11	LOA PC Asy STD 6 lamp 240V		\$ 956	
	43011-12	LOA PC Asy STD 8 lamp 240V		\$ 956	
	43011-13	PCB ASY LOA 220V 10 LMP		\$ 956	
	43011-14	PCB ASY LOA 220V 12 LMP		\$ 956	
	17896	LED asy (6 lamp std lamp)			\$ 369
	17890	LED asy (12 lamp std lamp)			\$ 441
	12861	Power Distribution Board T120 6 column used with electronic ballast			\$ 257
	12860	Power Distribution Board T120 6 column used with electronic ballast			\$ 216
Boards and Controls	16460	Lexan (up to 12 lamp)			\$ 28
	50757-3	Universal Controller membrane (Replaces 50757-1, 50757-2)			\$ 37
	50770-1	Ribbon Cable 16" Long			\$ 64
	50666	LCD Display		\$ 385	
	41114-2	KIT UV Monitoring Station		\$ 1,549	
	3170	Hour Meter -Round 120/60		\$ 169	
	3191	Hour Meter -Round 240/50		\$ 169	
	15843	Hour Meter-square 120/60		\$ 148	
	15844	Hour Meter-square 240/50		\$ 148	
	17745	Hour Meter-square 240/60		\$ 136	
19747-6	UVI METER ASY S254 110 HRZ	S254 Horizontal	\$ 1,196		
19747-7	UVI METER ASY S254 220 HRZ		\$ 1,098		
19747-12	UVI METER ASY S254/MA 110 HRZ		\$ 1,431		
19747-13	UVI METER ASY S254/MA 220 HRZ		\$ 1,314		











After Market Parts

Optima Series

Item	Part Number	Description	Picture	List Price (USD)	
UV Lamps	18197	Single lamp TOC / Chlorine 30"		\$ 255	
	18197-64	Bulk Price (+64 count) - Single lamp SE TOC / Chlorine 30"		\$ 194	
	17820	Single lamp TOC / Chlorine 60"		\$ 294	
	17820-64	Bulk Price (+64 count) - Single lamp SE TOC / Chlorine 60"		\$ 219	
		18952	Single lamp Validated TOC / Chlorine 30"		\$ 342
		18953	Single lamp Validated TOC / Chlorine 60"		\$ 342
Quartz Sleeves	18347	22.5mm X 30" DE		\$ 101	
	18348	22.5mm 60" DE		\$ 150	
	3184	25mm X 30" DE		\$ 101	
	3198	25mm X 60" DE		\$ 149	
Quartz Sleeves O-rings	40413	Viton		\$ 12	
	4253	EPDM		\$ 11	
	12967	Silicon		\$ 11	
	16600	Chemraz		\$ 431	
Bumper (spacer)	4255	EPDM 25mm		\$ 10	
	40420	Viton 25mm		\$ 62	
	40364	EPDM 22.5mm		\$ 14	
	40419	Viton 22.5mm		\$ 13	
For Electro Magnetic Ballast retrofit kits reference 'Retrofit Parts' page					
Ballast	43474-3	Electronic ballast 120/240 V (Replaces 43474-1)		\$ 752	
	19221-6	3 pin ballast connector assembly (For ballast 43474-3)		\$ 63	
	40331-6	4 pin ballast connector assembly (For ballast 43474-3)		\$ 70	

















After Market Parts

Optima Series

Item	Part Number	Description	Picture	List Price (USD)
	18468	Compression nut Stainless steel 22.5mm		\$ 193
	40357	Compression Nut Stainless Steel 25mm		\$ 193
	17489-1	Compression Nut cap without hole		\$ 21
	47520-3	Lamp Socket kit 8ft		\$ 73
Compression Nuts and Lamp Sockets	47387-8	Lamp Socket SE 8 ft.		\$ 55
	47597	Wave Spring (Replaces 47518)		\$ 6
	17489-5	Lamp cap with hole (used with lamp socket 47387)		\$ 21
	47520-5	Lamp Socket kit 16ft		\$ 81
	47387-16	Lamp Socket SE 16 ft.		\$ 63
	47597	Wave Spring (Replaces 47518)		\$ 6
	17489-5	Lamp cap with hole (used with lamp socket 47387)		\$ 21
	51049	SE Compression Nut Tool		\$ 205

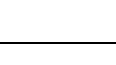







After Market Parts

Optima Series

Item	Part Number	Description	Picture	List Price (USD)
	43240-1	Assembly Kit Detector		\$ 1,652
	42601	X-254 Detector		\$ 1,466
	41116	20 ft. Cable for X-254		\$ 213
	43240	Assembly Kit Detector with NIST Certificate		\$ 2,506
	43055	NIST Certificate for 42601		\$ 854
	42601	X-254 Detector		\$ 1,466
	41116	20 ft. Cable for X-254		\$ 213
	48425	X-254 UV/Temperature Hermetically Sealed Detector		\$ 2,322
	16956	Sensor Port Plug		\$ 123
	40432	O-ring Viton		\$ 14
UV Intensity (UVI) Sensor	16881	O-ring EPDM		\$ 10
	41116	20 ft. Cable for X-254		\$ 213
	13898	Coax cable assembly 5 ft.		\$ 62
	14150	Coax cable assembly 15 ft.		\$ 77
	18176-1	S-254 Sensor-360 1-6 lamps		\$ 1,219
	18176-3	S-254 Sensor-360 8-12 lamps		\$ 1,219
	40246	Sensor window kit (For S-254)		\$ 393
	40007	Sensor quartz high hat		\$ 205
	40535	Flat fiber washer		\$ 7
	40008	Short sensor spacer		\$ 226
40416	Sensor o-ring Viton		\$ 11	













After Market Parts

Optima Series

Item	Part Number	Description	Picture	List Price (USD)
	19747-6	Meter Assembly S-254 controller (horizontal) 120V	S-254	\$ 1,196
	19747-12	Meter Assembly S-254 controller (horizontal mt) 120V w 4-20mA		\$ 1,431
	19747-7	Meter Assembly S-254 controller (horizontal mt) 240V		\$ 1,098
	19747-13	Meter Assembly S-254 controller (horizontal mt) 240V w 4-20mA		\$ 1,314
	19747-4	Meter Assembly S-254 controller(vertical mt) 120V		\$ 1,098
	19747-10	Meter Assembly S-254 controller (vertical) 120V w 4-20mA		\$ 1,314
	19747-5	Meter Assembly S-254 controller (vertical mt) 240V		\$ 1,098
UV Intensity (UVI) Sensor	19747-11	Meter Assembly S-254 controller (vertical mt) 240V w 4-20mA		\$ 1,314
	19747-2	Meter Assembly S-254 controller Remote 120 V		\$ 1,196
	19747-8	Meter Assembly S-254 controller Remote w 4-20mA 120V		\$ 1,314
	19747-3	Meter Assembly S-254 controller Remote 240V		\$ 1,098
	19747-9	Meter Assembly S-254 controller Remote w 4-20mA 240V		\$ 1,314
	19747-2	Meter Assembly S-254 controller Remote 120 V		\$ 1,196
	19747-8	Meter Assembly S-254 controller Remote w 4-20mA 240V		\$ 1,314
	792947-1	Surface mount temperature switch only		\$ 100
Temperature Sensor	16957	Thermistor (requires Swagelok)		\$ 350
	19537	Swagelok 3/8 NPTx3/16"		\$ 160
	4055	Swagelok1/4 NPTx3/16"		\$ 96
End Plate Gaskets	3118	EPDM 6" treatment chamber gasket		\$ 23
	16673	Viton 6" treatment chamber gasket		\$ 243
	12131	Silicone 6" treatment chamber gasket		\$ 179
	3244	EPDM 8" treatment chamber gasket		\$ 64
	16674	Viton 8" treatment chamber gasket		\$ 778
	12132	Silicone 8" treatment chamber gasket		\$ 392

After Market Parts

Optima Series

Item	Part Number	Description	Picture	List Price (USD)
Fan	3901	4" fan120 VAC		\$ 130
	3903	4" fan 240 VAC		\$ 118
	15843	Hour Meter-square 120/60		\$ 148
	15844	Hour Meter-square 240/50		\$ 148
	17745	Hour Meter-square 240/60		\$ 136
	3170	Hour Meter -Round 120/60		\$ 169
	3191	Hour Meter -Round 240/50		\$ 169
	3192	Hour Meter -Round 260/50		\$ 206
	12861	Power Dist Board for T120		\$ 257
	12860	Power Dist Board for no T120		\$ 216
	16460	Lexan (up to 12 lamp)		\$ 28
	40337-6	LED asy (up to 6 lamp HE/HX)		\$ 308
	40337-12	LED asy (up to 12 lamp HE/HX)		\$ 408
Boards and Controls	43011-16	LOA PC Asy HE/HX 4 lamp 120V		\$ 984
	43011-18	LOA PC Asy HE/HX 6 lamp 120V		\$ 984
	43011-19	LOA PC Asy HE/HX 8 lamp 120V		\$ 984
	43011-20	LOA PC Asy HE/HX 10 lamp 120V		\$ 984
	43011-21	LOA PC Asy HE/HX 12 lamp 120V		\$ 984
	43011-23	LOA PC Asy HE/HX 4 lamp 240V		\$ 984
	43011-25	LOA PC Asy HE/HX 6 lamp 240V		\$ 984
	43011-26	LOA PC Asy HE/HX 8 lamp 240V		\$ 984
	43011-27	LOA PC Asy HE/HX 10 lamp 240V		\$ 984
	43011-28	LOA PC Asy HE/HX12 lamp 240V	\$ 984	
	41114-2	X-254 Monitoring Station (UV/Temp)		\$ 1,549
	41817	Snubber		\$ 21
41114-1	X-254 Monitoring Station (UV/Temp)		\$ 1,457	

After Market Parts

Optima HX and Optima HX Mini

Item	Part Number	Description	Picture	List Price (USD)
UV Lamps	Gold-M	Single lamp Disinfection / Ozone destruction 15"		\$ 115
	Gold-S	Single lamp Disinfection / Ozone destruction 30"		\$ 156
	Gold-S4	4-pack lamps Disinfection / Ozone destruction 30"		\$ 578
	Gold-S32	32-pack lamps Disinfection / Ozone destruction 30"		\$ 4,508
	Gold-L	Single lamp Disinfection / Ozone destruction 60"		\$ 232
	Gold-L4	4-pack lamps Disinfection / Ozone destruction 60"		\$ 870
	Gold-L32	32-pack lamps Disinfection / Ozone destruction 60"		\$ 6,814
	Cream-M	Single lamp Validate Disinfection / Ozone destruction 15"		
	Cream-S	Single lamp Validated Disinfection / Ozone destruction 30"	\$ 248	
	Cream-L	Single lamp Validated Disinfection / Ozone destruction 60"	\$ 326	
	Silver-L	Single lamp SE TOC / Chlorine 60"		\$ 266
	Silver-L4	4-pack lamps SE TOC / Chlorine 60"		\$ 997
	Silver-L32	32-pack lamps SE TOC / Chlorine 60"		\$ 7,826
	Silver-M	Single lamp SE TOC 14"		\$ 164
	Silver-S	Single lamp SE TOC 30"		\$ 200
Quartz Sleeves	45034	25mm X 15" DE		\$ 83
	3184	25mm X 30" DE		\$ 101
	3198	25mm X 60" DE		\$ 149
Quartz Sleeves O-rings	40413	Viton		\$ 12
	4253	EPDM		\$ 11
	12967	Silicon		\$ 11
	16600	Chemraz		\$ 431
Bumper (spacer)	4255	EPDM 25mm		\$ 10
	40420	Viton 25mm		\$ 62
	40776-3	Bushing 25mm quartz		\$ 54











After Market Parts

Optima HX and Optima HX Mini

Item	Part Number	Description	Picture	List Price (USD)
	18468	Compression nut Stainless steel 22.5mm		\$ 193
	40357	Compression Nut Stainless Steel 25mm		\$ 193
	17489-1	Compression Nut cap without hole		\$ 21
	47520-3	Lamp Socket kit 8ft		\$ 73
	47387-8	Lamp Socket SE 8 ft.		\$ 55
Compression Nuts and Lamp Sockets	47597	Wave Spring (Replaces 47518)		\$ 6
	17489-5	Lamp cap with hole (used with lamp socket 47387)		\$ 21
	47520-5	Lamp Socket kit 16ft		\$ 81
	47387-16	Lamp Socket SE 16 ft.		\$ 63
	47597	Wave Spring (Replaces 47518)		\$ 6
	17489-5	Lamp cap with hole (used with lamp socket 47387)		\$ 21
	51049	SE Compression Nut Tool		\$ 205
	43240-1	Assembly Kit Detector		\$ 1,652
UV Intensity (UVI) Sensor	42601	X-254 Detector		\$ 1,466
	41116	20 ft. Cable for X-254		\$ 213













After Market Parts

Optima HX and Optima HX Mini

Item	Part Number	Description	Picture	List Price (USD)
	43240	Assembly Kit Detector with NIST Certificate		\$ 2,506
	43055	NIST Certificate for 42601		\$ 854
	42601	X-254 Detector		\$ 1,466
	41116	20 ft. Cable for X-254		\$ 213
UV Intensity (UVI) Sensor	48425	X-254 UV/Temperature Hermetically Sealed Detector		\$ 2,322
	16956	Sensor Port Plug		\$ 123
	40432	O-ring Viton		\$ 14
	16881	O-ring EPDM		\$ 10
	41116	20 ft. Cable for X-254		\$ 213
Temperature Sensor (T-120)	792947-1	Surface mount temperature switch only		\$ 100
	43791-1	EPDM - "B" 4"		\$ 227
	43791-2	Viton - "B" 4"		\$ 227
	3118	EPDM 6" treatment chamber gasket		\$ 23
	16673	Viton 6" treatment chamber gasket		\$ 243
	12131	Silicone 6" treatment chamber gasket		\$ 179
End Plate Gaskets	3244	EPDM 8" treatment chamber gasket		\$ 64
	16674	Viton 8" treatment chamber gasket		\$ 778
	12132	Silicone 8" treatment chamber gasket		\$ 392
	16790	EPDM 10" treatment chamber o-ring		\$ 81
	40427	Viton 10" treatment chamber o-ring		\$ 349
	15601	EPDM 12" treatment chamber o-ring		\$ 92
	40428	Viton 12" treatment chamber o-ring		\$ 426











After Market Parts

Optima HX and Optima HX Mini

Item	Part Number	Description	Picture	List Price (USD)
End Plate Gaskets	16063	EPDM 14" treatment chamber o-ring		\$ 102
	40429	Viton 14" treatment chamber o-ring		\$ 441
For Electro Magnetic Ballast retrofit kits reference 'Retrofit Parts' page				
Ballast	43474-3	Electronic ballast 120/240 V (Replace 43474-1)		\$ 752
	45040	Electronic ballast 120/240 V - Mini models		\$ 396
	19221-6	3 pin ballast connector assembly (For ballast 43474-3)		\$ 63
	40331-6	4 pin ballast connector assembly (For ballast 43474-3)		\$ 70
Fan	4205	2" fan 120 VAC		\$ 169
	4206	2" fan 240 VAC		\$ 214
	3901	4" fan 120 VAC		\$ 130
	3903	4" fan 240 VAC		\$ 118
	15843	Hour Meter-square 120/60		\$ 148
	15844	Hour Meter-square 240/50		\$ 148
	17745	Hour Meter-square 240/60		\$ 136
	19366-1	LED asy 1 HE/HX lamp		\$ 85
	19366	LED asy 2 lamp HE/HX lamp		\$ 91
	16460	Lexan (up to 12 lamp)		\$ 28
Boards and Controls	40337-6	LED asy (up to 6 lamp HE/HX)		\$ 308
	40337-12	LED asy (up to 12 lamp HE/HX)		\$ 408
	43011-15	LOA PC Asy HE/HX 2 lamp 120V		\$ 984
	43011-16	LOA PC Asy HE/HX 4 lamp 120V		\$ 984
	43011-17	LOA PC Asy HE/HX 5 lamp 120V		\$ 984
	43011-18	LOA PC Asy HE/HX 6 lamp 120V		\$ 984
	43011-19	LOA PC Asy HE/HX 8 lamp 120V		\$ 984
	43011-20	LOA PC Asy HE/HX 10 lamp 120V		\$ 984
	43011-21	LOA PC Asy HE/HX 12 lamp 120V		\$ 984
	43011-22	LOA PC Asy HE/HX 2 lamp 240V		\$ 984
	43011-23	LOA PC Asy HE/HX 4 lamp 240V		\$ 984
	43011-24	LOA PC Asy HE/HX 5 lamp 240V		\$ 984
	43011-25	LOA PC Asy HE/HX 6 lamp 240V		\$ 984
	43011-26	LOA PC Asy HE/HX 8 lamp 240V		\$ 984
	43011-27	LOA PC Asy HE/HX 10 lamp 240V		\$ 984
	43011-28	LOA PC Asy HE/HX 12 lamp 240V		\$ 984

After Market Parts

Optima HX and Optima HX Mini

Item	Part Number	Description	Picture	List Price (USD)
	41114-2	X-254 Monitoring Station (UV/Temp)		\$ 1,549
	41817	Snubber		\$ 21
	41114-1	X-254 Monitoring Station (UV/Temp)		\$ 1,457
	51279-4N	G400 controller with software - 4 lamp - no detector		\$ 4,558
	51279-6N	G400 controller with software - 6 lamp - no detector		\$ 4,558
	51279-8N	G400 controller with software - 8 lamp - no detector		\$ 4,558
	51279-10N	G400 controller with software - 10 lamp - no detector		\$ 4,558
	51279-12N	G400 controller with software - 12 lamp - no detector		\$ 4,558
	51279-4D	G400 controller with software - 4 lamp - with detector enabled		\$ 4,558
	51279-6D	G400 controller with software - 6 lamp - with detector enabled		\$ 4,558
	51279-8D	G400 controller with software - 8 lamp - with detector enabled		\$ 4,558
	51279-10D	G400 controller with software - 10 lamp - with detector enabled		\$ 4,558
Boards and Controls	51279-12D	G400 controller with software - 12 lamp - with detector enabled		\$ 4,558
	41797-2	MUX Board for HE/HX electronic ballast (2-12 lamp)		\$ 1,585
	42119	4-20mA analog module		\$ 1,107
	48446	Expansion Mod w 1m Cable		\$ 299
	19367	LOA PC asy HE\HX 1 lamp		\$ 185
	48447	Cable, I/O expansion, 2M		\$ 186
	41991	Power supply 24VDC 60W		\$ 337
	42449	Power supply 24VDC 100W		\$ 870
	43074	Signal Cond for detector 24V/5V		\$ 343













After Market Parts

SCD / SCD H / SCD HE

Item	Part Number	Description	Picture	List Price (USD)
	Silver-L	Single lamp SE TOC / Chlorine 60", HX SE		\$ 266
	Silver-L4	4-pack lamps SE TOC / Chlorine 60", HX SE		\$ 997
	Silver-L32	32-pack lamps SE TOC / Chlorine 60", HX SE		\$ 7,826
	Cream-L	Validated Disinfection / Ozone destruction 60", HX SE		\$ 326
	Tan-L	Validated SE TOC / Chlorine 60", HX SE		\$ 354
	Gold-L	Disinfection / Ozone destruction 60", HX SE		\$ 232
	17998LM	Disinfection / Ozone destruction 60" Std SE		\$ 170
	18060	Validated Disinfection / Ozone destruction 60", Std SE		\$ 277
	18061	Validated TOC / Chlorine 60", Std SE		\$ 361
	18198	Disinfection / Ozone destruction 30", HE SE		\$ 236
	18024	Disinfection / Ozone destruction 60", HE SE		\$ 271
UV Lamps	18950	Validated Disinfection / Ozone destruction 30", HE SE		\$ 293
	18951	Validated Disinfection / Ozone destruction 60", HE SE		\$ 338
	18197	TOC / Chlorine 30", HE SE		\$ 255
	17820	TOC / Chlorine 60", HE SE		\$ 294
	18952	Validated TOC / Chlorine 30", HE SE		\$ 342
	18953	Validated TOC / Chlorine 60", HE SE		\$ 342
	3098LM	Disinfection / Ozone destruction 60" Std DE		\$ 141
	3095	TOC/Chlorine 60", Std DE		\$ 182
	16677	Validated Disinfection / Ozone destruction 60", Std DE		\$ 265
	3095	TOC / Chlorine 60", Std DE		\$ 182
	16679	Validated TOC / Chlorine 60", Std DE		\$ 340











After Market Parts

SCD / SCD H / SCD HE

Item	Part Number	Description	Picture	List Price (USD)
Quartz Sleeves	17751	Single Ended-domed ended 22.5mm X 60" SE		\$ 150
	16791	Single Ended-domed ended 25mm X 60" SE		\$ 145
	18348	Double ended-open ended 22.5mm X 60" DE		\$ 150
	3198	Double ended-open ended 25mm X 60" DE		\$ 149
Quartz Sleeves O-rings	40413	Viton		\$ 12
	4253	EPDM		\$ 11
	12967	Silicon		\$ 11
	16600	Chemraz		\$ 431
Teflon Bushing	17490	Bushing 22.5mm quartz, 14 gauge		\$ 21
	19737	Bushing 25mm quartz 16 gauge		\$ 21
Bumper (spacer)	4255	EPDM 25mm		\$ 10
	40420	Viton 25mm		\$ 62
	40364	EPDM 22.5mm		\$ 14
	40419	Viton 22.5mm		\$ 13
For Electro Magnetic Ballast retrofit kits reference 'Retrofit Parts' page				
Ballast	43474-3	Electronic ballast 120/240 V, HE / HX lamp replaces 41634-1, 19202, 40328		\$ 752
	19221-6	3 pin ballast connector assembly		\$ 63
	16518-3	120/240 V Electronic ballast (non HE/HX, replaces 16518) (Replace 16518-1)		\$ 278
	40331-6	4 pin ballast connector assembly		\$ 70
	16519	5 pin ballast connector assembly		\$ 47

After Market Parts

SCD / SCD H / SCD HE

Item	Part Number	Description	Picture	List Price (USD)
	18468	Compression nut Stainless steel 22.5mm		\$ 193
	40357	Compression Nut Stainless Steel 25mm		\$ 193
	17489-1	Compression Nut cap without hole		\$ 21
	47520-3	Lamp Socket kit 8ft		\$ 73
	47387-8	Lamp Socket SE 8 ft.		\$ 55
	47597	Wave Spring (Replaces 47518)		\$ 6
Compression Nuts and Lamp Sockets	17489-5	Lamp cap with hole (used with lamp socket 47387)		\$ 21
	47520-5	Lamp Socket kit 16ft		\$ 81
	47387-16	Lamp Socket SE 16 ft.		\$ 63
	47597	Wave Spring (Replaces 47518)		\$ 6
	17489-5	Lamp cap with hole (used with lamp socket 47387)		\$ 21
	51049	SE Compression Nut Tool		\$ 205
	53399	Liquid Sweetener Compression Nut (replaces 18517)		\$ 29

After Market Parts

SCD / SCD H / SCD HE

Item	Part Number	Description	Picture	List Price (USD)
	13899	Double Ended (DE) Socket Lok Asy, 5 pcs		\$ 78
	12423	Spring		\$ 11
	12421	Large cap (spring side)		\$ 21
	12420	Small cap		\$ 20
Compression Nuts and Lamp Sockets	12422	DE Compression Nut, CPVC 25mm		\$ 30
	4252	DE Compression Nut CPVC 25mm		\$ 25
	3105	DE Compression Nut wrench		\$ 99
	16184-1	DE lamp Socket 8 ft.		\$ 40
	16184	DE lamp Socket 2 ft.		\$ 28
	16898	DE Compression Nut, Stainless steel 25mm		\$ 193
	43240-1	Assembly Kit Detector		\$ 1,652
	42601	X-254 Detector		\$ 1,466
	41116	20 ft. Cable for X-254		\$ 213
	43240	Assembly Kit Detector with NIST Certificate		\$ 2,506
UV Intensity (UVI) Sensor	43055	NIST Certificate for 42601		\$ 854
	42601	X-254 Detector		\$ 1,466
	41116	20 ft. Cable for X-254		\$ 213
	48425	X-254 UV/Temperature Hermetically Sealed Detector		\$ 2,322







After Market Parts

SCD / SCD H / SCD HE

Item	Part Number	Description	Picture	List Price (USD)
	16956	Sensor Port Plug		\$ 123
	40432	O-ring Viton		\$ 14
	16881	O-ring EPDM		\$ 10
	41116	20 ft. Cable for X-254		\$ 213
	18176-1	S-254 Sensor-360 1-6 lamps		\$ 1,219
	18176-3	S-254 Sensor-360 8-12 lamps		\$ 1,219
	18176-3	S-254 Sensor-360 16 - 36 lamps		\$ 1,219
UV Intensity (UVI) Sensor	40246	Sensor window kit (For S-254)		\$ 393
	40007	Sensor quartz high hat		\$ 205
	40535	Flat fiber washer		\$ 7
	40008	Short sensor spacer		\$ 226
	40416	Sensor o-ring Viton		\$ 11
	16571	Top Mount UV sensor S254 90 DEG.		\$ 1,382
	12889	S-254 sensor port plug assembly		\$ 105
	13898	Coax cable assembly 5 ft.		\$ 62
	14150	Coax cable assembly 15 ft.		\$ 77







After Market Parts

SCD / SCD H / SCD HE

Item	Part Number	Description	Picture	List Price (USD)
Temperature Sensor	17405	Thermistor retrofit kit		\$ 987
	792947-1	Surface mount temperature switch only		\$ 100
	16957	Thermistor (requires Swagelok)		\$ 350
	19537	Swagelok 3/8 NPTx3/16"		\$ 160
	4055	Swagelok 1/4 NPTx3/16"		\$ 96
End Plate Gaskets	15601	EPDM 12" treatment chamber o-ring	600H, 700H	\$ 92
	40428	Viton 12" treatment chamber o-ring		\$ 426
	16063	EPDM 14" treatment chamber o-ring	1000H, 1200H, 1350H, 1450H	\$ 102
	40429	Viton 14" treatment chamber o-ring		\$ 441
	42037	EPDM 16" treatment chamber o-ring	1750H	\$ 107
	42339	Viton 16" treatment chamber o-ring		\$ 321
Fan	3901	4" fan 120 VAC (SCD)		\$ 130
	3903	4" fan 240 VAC (SCD)		\$ 118
	44717	4" fan 24VDC 200 cfm		\$ 153
	41903	4" fan 24VDC, 100cfm		\$ 199
	18209	8" fan 120 VAC		\$ 1,875
	19405	8" fan 240 VAC		\$ 1,912







After Market Parts

SCD / SCD H / SCD HE

Item	Part Number	Description	Picture	List Price (USD)
	51279-16N	G400 controller with software - 16 lamp - no detector		\$ 4,558
	51279-20N	G400 controller with software - 20 lamp - no detector		\$ 4,558
	51279-24N	G400 controller with software - 24 lamp - no detector		\$ 4,558
	51279-36N	G400 controller with software - 36 lamp - no detector		\$ 4,558
	51279-40N	G400 controller with software - 40 lamp - no detector		\$ 4,558
	51279-44N	G400 controller with software - 44 lamp - no detector		\$ 4,558
	51279-16D	G400 controller with software - 16 lamp - with detector enabled		\$ 4,558
	51279-20D	G400 controller with software - 20 lamp - with detector enabled		\$ 4,558
	51279-24D	G400 controller with software - 24 lamp - with detector enabled		\$ 4,558
	51279-36D	G400 controller with software - 36 lamp - with detector enabled		\$ 4,558
Boards and Controls	51279-40D	G400 controller with software - 40 lamp - with detector enabled		\$ 4,558
	51279-44D	G400 controller with software - 44 lamp - with detector enabled		\$ 4,558
	41963	MUX board HE/HX electronic ballast (16-44 lamp)		\$ 1,419
	42119	4-20mA analog module		\$ 1,107
	41991	Power supply 24VDC 60W		\$ 337
	42449	Power supply 24VDC 100W		\$ 870
	43074	Signal Cond for detector 24V/5V		\$ 343
	48446	Expansion Mod w 1m Cable		\$ 299
	48447	Cable, I/O expansion, 2M		\$ 186







After Market Parts

SCD / SCD H / SCD HE

Item	Part Number	Description	Picture	List Price (USD)
	19747-6	Meter Assembly S-254 controller (horizontal) 120V		\$ 1,196
	19747-7	Meter Assembly S-254 controller (horizontal mt) 240V		\$ 1,098
	19747-12	Meter Assembly S-254 controller (horizontal mt) 120V w 4-20mA		\$ 1,431
	19747-13	Meter Assembly S-254 controller (horizontal mt) 240V w 4-20mA		\$ 1,314
	15843	Hour Meter-square 120/60		\$ 148
	15844	Hour Meter-square 240/50		\$ 148
	17745	Hour Meter-square 240/60		\$ 136
	18907	LED CMPNT asy 12 std lamp 16 pin		\$ 441
	18656	Ribbon cable for 16 pin		\$ 55
Boards and Controls	19208-36	CSB elec ballast (16-36 lamp), Aqua		\$ 4,972
	41071-36	SDB-with S-254+ Thermistor (16-36 lamp)		\$ 4,972
	41176-36	SDB with -X-254 detector (16-36 lamp)		\$ 4,972
	17813	Ribbon cable 5ft for Aqualogic		\$ 118
	43011-12	PCB ASY LOA 220V 8 LMP		\$ 956
	43011-13	PCB ASY LOA 220V 10 LMP		\$ 956
	43011-14	PCB ASY LOA 220V 12 LMP		\$ 956
	43011-19	PCB ASY LOA 120V HE 8 LMP		\$ 984
	43011-20	PCB ASY LOA 120V HE 10LMP		\$ 984
	43011-21	PCB ASY LOA 120V HE 12LMP		\$ 984
	43011-26	PCB ASY LOA 220V HE 8 LMP		\$ 984
	43011-27	PCB ASY LOA 220V HE 10LMP		\$ 984
	43011-28	PCB ASY LOA 220V HE 12LMP		\$ 984

After Market Parts

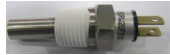
MPR / ChloRid Series

Item	Part Number	Description	Picture	List Price (USD)
UV Lamp	820856	Lamp Assembly MPR, 30CM		\$ 1,098
Quartz Sleeve	820087	Quartz Sleeve		\$ 340
Ballast	915109	UV Lamp Ballast (1 Lamp) 3200W		\$ 4,502
Lamp Socket	820386-025	LAMP CONNECTION ASSEMBLY 25'		\$ 311
O-rings, Gaskets and others	44709	O-RING 2-123, WIPER - EPDM		\$ 12
	44770	O-RING 2-033-AN - EPDM		\$ 12
	44769	O-RING 2-235 - EPDM		\$ 15
	793644-001	SANI GASKET 1" & 1.5"		\$ 11
	15601	ENDPLATE O-RING 12" - EPDM		\$ 92
	002189	O-RING #325 - TEFLON ENCAPSULATED		\$ 39
Controls	51279-01N	V130 SERIES CONTROLLER - 1 Lamp - No dose display		\$ 4,603
	51279-01D	V130 SERIES CONTROLLER - 1 Lamp - With dose display		\$ 4,603
	51279-02N	V130 SERIES CONTROLLER - 2 Lamps - No dose display		\$ 4,603
	51279-02D	V130 SERIES CONTROLLER - 2 Lamps - With dose display		\$ 4,603
	51279-04N	V130 SERIES CONTROLLER - 4 Lamps - No dose display		\$ 4,603
	51279-04D	V130 SERIES CONTROLLER - 4 Lamps - With dose display		\$ 4,603
	48446	Expansion Mod w 1m Cable		\$ 299
	48447	Cable, I/O expansion, 2M		\$ 186
	42119	4-20mA analog module		\$ 1,107
	Sensors	44950	Liquid Level Switch	
44949		Temperature Switch 3/8" NPT		\$ 544
48702		SENSOR ASSY GROUP MPR/CHL		\$ 10,069













After Market Parts

MPR / ChloRid Series

Item	Part Number	Description	Picture	List Price (USD)
	793590	MICRO LIMIT SWITCH - LAMP COVER		\$ 21
	44818	INDUCTIVE PROXIMITY SENSOR - WIPER		\$ 426
	820359	MAGNETIC ASSEMBLY HOME SWITCH		\$ 336
	820552-124	REED ASSEMBLY HOMING 12-24UVS		\$ 355
	44965	FUSE 30 AMP 600V		\$ 80
	44717	FAN, 24VDC		\$ 153
	3176	SANI CLAMP		\$ 42
	43590	SOCKET COVER		\$ 266
Other	794006	GEAR MOTOR & REDUCER 5:1		\$ 1,622
	820092	ROD SEAL .50 ID - WIPER		\$ 77
	820034	BEARING FLANGE		\$ 68
	45342-1	WIPER MOTOR MOUNT		\$ 492
	45347	ACME SCREW		\$ 2,260
	793140	COUPLING ASSEMBLY		\$ 209
	792975	KEY 1/8" x 3/4"		\$ 30
	794380	WIPER COLLAR		\$ 47
	820026	WIPER SLEEVE 39MM		\$ 24
	794244	BALL BEARING		\$ 289

















After Market Parts

SL1 and MP2SL Series

Item	Part Number	Description	Picture	List Price (USD)
	17491LM	Single lamp SE Disinfection / Ozone destruction 30"		\$ 131
	17491LM-4	4-pack lamps SE Disinfection / Ozone destruction 30"		\$ 486
	17491LM-32	32-pack lamps SE Disinfection / Ozone destruction 30"		\$ 3,529
	18059	Single lamp SE Validated Disinfection / Ozone destruction 30"		\$ 204
	18063	Single lamp SE TOC / Chlorine 30"		\$ 134
	18063-4	4-pack lamps SE TOC / Chlorine 30"		\$ 508
	18063-32	32-pack lamps SE TOC / Chlorine 30"		\$ 3,250
	18062	Single lamp SE Validated TOC / Chlorine 30"		\$ 253
UV Lamps	3087	TOC/Chlorine 30" (SL-1, MP-2)		\$ 129
	3084LM	Disinfection / Ozone destruction 30"		\$ 106
	16676	Validated Disinfection / Ozone destruction 30"		\$ 193
	16714	Validated Disinfection / Ozone destruction 15"		\$ 176
	16678	Validated TOC / Chlorine 30"		\$ 239
	16715	Validated TOC / Chlorine 15"		\$ 170
	18347	22.5mm X 30" DE (SL-10A)		\$ 101
Quartz Sleeves	3184	25mm X 30" DE (SL-1, MP-2)		\$ 101
	3150	25mm X 13" DE (SL-1, MP-2)		\$ 67
	40413	Viton		\$ 12
Quartz Sleeve O-rings	4253	EPDM		\$ 11
	12967	Silicon		\$ 11
	16600	Chemraz		\$ 431
	40364	EPDM 22.5mm		\$ 14
Bumper (Spacer)	40419	Viton 22.5mm		\$ 13
	4255	EPDM 25mm		\$ 10
	40420	Viton 25mm		\$ 62









After Market Parts

SL1 and MP2SL Series

Item	Part Number	Description	Picture	List Price (USD)
	40357	Compression Nut Stainless Steel 25mm		\$ 193
	18468	Compression Nut Stainless Steel 22.5mm		\$ 193
	51049	SE Compression Nut Tool		\$ 205
	17489-1	Compression Nut cap without hole		\$ 21
	47520-1	Lamp Socket kit 3ft		\$ 60
	47387-3	Lamp Socket SE 3 ft.		\$ 43
	47597	Wave Spring (Replaces 47518)		\$ 6
	17489-5	Lamp cap with hole (used with lamp socket 47387)		\$ 21
Compression Nuts and Lamp Sockets	47520-3	Lamp Socket kit 8ft		\$ 73
	47387-8	Lamp Socket SE 8 ft.		\$ 55
	47597	Wave Spring (Replaces 47518)		\$ 6
	17489-5	Lamp cap with hole (used with lamp socket 47387)		\$ 21
	47520-5	Lamp Socket kit 16ft		\$ 81
	47387-16	Lamp Socket SE 16 ft.		\$ 63
	47597	Wave Spring (Replaces 47518)		\$ 6
	17489-5	Lamp cap with hole (used with lamp socket 47387)		\$ 21

After Market Parts

SL1 and MP2SL Series

Item	Part Number	Description	Picture	List Price (USD)
	13899	Double Ended (DE) Socket Lok Asy, 5 pcs		\$ 78
	12423	Spring		\$ 11
	12421	Large cap (spring side)		\$ 21
	12420	Small cap		\$ 20
Compression Nuts and Lamp Sockets	12422	DE Compression Nut, CPVC 25mm		\$ 30
	16184-1	DE lamp Socket 8 ft.		\$ 40
	16184	DE lamp Socket 2 ft.		\$ 28
	16898	DE Compression Nut, Stainless steel 25mm		\$ 193
	4252	DE Compression Nut CPVC 25mm		\$ 25
	3105	DE Compression Nut wrench		\$ 99

After Market Parts

SL1 and MP2SL Series

Item	Part Number	Description	Picture	List Price (USD)	
For Electro Magnetic Ballast retrofit kits reference 'Retrofit Parts' page					
Ballast	16518-3	120/240 V Electronic ballast (Replace 16518-1)		\$ 278	
	16519	5 pin ballast connector assembly		\$ 47	
UV Intensity (UVI) Sensor	18176-1	S-254 UV Intensity Sensor (1-12 lamp - 360 DEG)		\$ 1,219	
	40246	Sensor Window Kit		\$ 393	
	16571	Top Mount UV Intensity Sensor S-254		\$ 1,382	
	48425	X-254 UV/Temperature Hermetically Sealed Detector		\$ 2,322	
	4252	Compression nut S-254		\$ 25	
	12889	S-254 Port Plug Assembly		\$ 105	
	40432	O-ring Viton (Used in 16881, 18176-X)		\$ 14	
	13898	Coax cable assembly 5 ft		\$ 62	
	14150	Coax cable assembly 15 ft		\$ 77	
		16956	PLUG, S-254 SNSR 3/4-16		\$ 123
		43240-1	Assembly Kit Detector		\$ 1,652
		42601	X-254 Detector		\$ 1,466
		41116	20 ft. Cable for X-254		\$ 213
		43240	Assembly Kit Detector with NIST Certificate		\$ 2,506
		43055	NIST Certificate for 42601		\$ 854
	42601	X-254 Detector		\$ 1,466	
	41116	20 ft. Cable for X-254		\$ 213	





After Market Parts

SL1 and MP2SL Series

Item	Part Number	Description	Picture	List Price (USD)
Temperature Sensors (T-120)	792947-1	Surface mount temperature switch only		\$ 100
	16957	Thermistor (requires swagelok)		\$ 350
	19537	swagelok 3/8 NPTx3/16"		\$ 160
	4055	swagelok 1/4 NPTx3/16"		\$ 96
	16958	Thermistor control board (T-120)		\$ 674
	17405	Thermistor retro kit		\$ 987
	Boards and Controls	15843	Hour Meter-square 120/60	
15844		Hour Meter-square 240/50		\$ 148
17745		Hour Meter-square 240/60		\$ 136
3170		Hour Meter -Round 120/60		\$ 169
3191		Hour Meter -Round 240/50		\$ 169
3192		Hour Meter -Round 260/50		\$ 206
12852		PCB ASY LOA-SIN 30"UNITS		\$ 157
16950		LED asy 1 std lamp		\$ 80
16951		LED asy 2 lamp std lamp		\$ 86
19747-2		METER ASY S254 110 RMT		\$ 1,196
19747-3		METER ASY S254 220 RMT		\$ 1,098
19747-8	METER ASY S254/MA 110 RMT		\$ 1,314	
19747-9	METER ASY S254/MA 220 RMT		\$ 1,314	
41114-2	X-254 Monitoring Station (UV/Temp)		\$ 1,549	
41817	Snubber		\$ 21	
41114-1	X-254 Monitoring Station (UV/Temp)		\$ 1,457	
Fans	4205	2" fan 120 VAC		\$ 169
	4206	2" fan 240 VAC		\$ 214
Treatment Chamber Gasket	4211	EPDM 3" gasket end plate		\$ 104









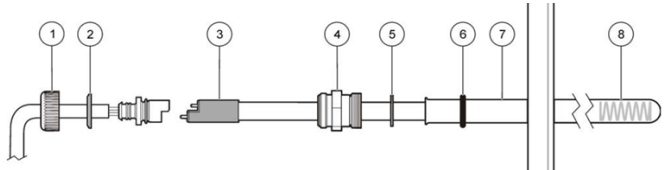

After Market Parts

UV Logics Series

Item	Part Number	Description	Picture	List Price (USD)
Lamps	794113	STANDARD UV LAMP (254 NM) (AM MODELS)		\$ 375
	793658	VALIDATED UV LAMP (254NM) (AM MODELS)		\$ 512
	794107	STANDARD UV LAMP (185 NM) (TM MODELS)		\$ 782
	793923	STANDARD UV LAMP (254 NM) (AS MODELS)		\$ 437
	793661	VALIDATED UV LAMP (254NM) (AS MODELS)		\$ 540
	794108	STANDARD UV LAMP (185 NM) (TS MODELS)		\$ 1,579
	302509	STANDARD UV LAMP (254 NM) (AL MODELS)		\$ 454
	793664	VALIDATED UV LAMP (254NM) (AL MODELS)		\$ 559
	794109	STANDARD UV LAMP (185 NM) (TL MODELS)		\$ 1,731
Quartz Sleeves	793075	QUARTZ SLEEVE (254 NM) (AM MODELS)		\$ 131
	792934	QUARTZ SLEEVE (254 NM) (AS MODELS)		\$ 146
	793024	QUARTZ SLEEVE (254 NM) (AL MODELS)		\$ 161
	793017	QUARTZ SLEEVE (185 NM) (TM MODELS)		\$ 1,315
	793016	QUARTZ SLEEVE (185 NM) (TS MODELS)		\$ 2,082
	793018	QUARTZ SLEEVE (185 NM) (TL MODELS)		\$ 2,056
	794316	REMOVAL TOOL, 28MM QUARTZ		\$ 715
Lamps Drivers	912513	UV LAMP BALLAST (1 - LAMP) (AM MODELS)		\$ 620
	917067	UV LAMP BALLAST (2 - LAMP) (AS/AL MODELS) Replaces 915243		\$ 1,030









After Market Parts

UV Logics Series

Item	Part Number	Description	Picture	List Price (USD)
		 <p>Step Lamp Base</p>		
	316148	SLEEVE CUP NUT UV3 MOD (Item 1)		\$ 14
	793859	WASHER SLEEVE BOLT CAP (Item 2)		\$ 29
	795750	Sleeve bolt, metal (Item 4)		\$ 92
Compression Nuts and Lamp Sockets	795771-1175	LAMP HOLDER, SSC A 17.5FT (AM MODELS)		\$ 192
	795771-1275	LAMP HOLDER, SSC A 27.5 FT		\$ 249
	795771-1525	LAMP HOLDER, SSC A 52.5 FT		\$ 374
	795771-1775	LAMP HOLDER, SSC A 77.5 FT		\$ 497
	792931	Cushion washer (Item 5)		\$ 16
	796054	LAMP SPRING (AS/AL & AM MODELS) (Item 8)		\$ 11
	792437	Sleeve oring EPDM (Item 6)		\$ 10
	002190-215F	Sleeve oring Viton (Item 6)		\$ 16
	901554	TOOL,28mm SLEEVE BOLT		\$ 522
	792718-1175	17' LAMP CONNECTORS (AS/AL MODELS)		\$ 192
	792718-1275	21' LAMP CONNECTORS (AS/AL MODELS)		\$ 249
	792718-1525	52' LAMP CONNECTORS (AS/AL MODELS)		\$ 374

After Market Parts

UV Logics Series

Item	Part Number	Description	Picture	List Price (USD)
	793200-001	UVLOGIC SENSOR WITH CABLE 3' AS/AL		\$ 1,087
	793200-004	UVLOGIC SENSOR WITH CABLE 21' AM		\$ 1,724
	794287	SENSOR ADAPTER, GERS		\$ 666
UV Intensity (UVI) Sensor	013213-200	2" sanitary clamp		\$ 75
	820693-003	Gasket 2" sanitary, Viton		\$ 20
	002190-026f	O-ring 1.257X .063 Viton		\$ 14
	002026	SENSOR O-RING - VITON®		\$ 12
	914129-002	HARNESS ASSY, TEMP 35' 50DEG C		\$ 125
Temperature Switch	794540-001	HARNESS ASSEMBLY 50° C TEMP. SWITCH 17' (AM MODELS)		\$ 390
	794540-003	HARNESS ASSEMBLY 50° C TEMP. SWITCH 20' (AM MODELS)		\$ 280
	792947	TEMPERATURE SWITCH 120F		\$ 83
End Plate O-rings and Sanitary Gaskets	793465	4" END PLATE O-RING (AM MODELS)		\$ 20
	793418	6" END PLATE O-RING (AM MODELS)		\$ 22
	820693-008	GASKET SANITARY 8" VITON		\$ 240
	820693-006	GASKET, SANITARY 6" VITON		\$ 191
	002190-123F	O-ring Viton 20cm reactors		\$ 14
	002190-279F	O-ring Viton 30cm reactors		\$ 383
	002190-386F	O-ring Viton 40cm reactors		\$ 581
	002190-470F	O-ring Viton 50cm reactors		\$ 490

After Market Parts

UV Logics Series

Item	Part Number	Description	Picture	List Price (USD)
	931066-001	TROJANUVLOGIC P-40 BOARD AS/AL/AM		\$ 3,318
	931122-001	BOARD,P40 ETHERNET ETHER		\$ 2,069
	931122-002	BOARD, P40 ETHERNET MODBUSTCP		\$ 2,069
	931122-003	BOARD, P40 ETHERNET PROFINET		\$ 2,069
Boards and Controls				
	931067	4-20Ma ANALOG OUTPUT MODULE, P-40 CONTROL BOARD		\$ 986
	931080-001	BOARD, P40 ETHERNET MODBUS RTU RS485		\$ 542
	912491	INTERFACE BOARD 120V (AM MODELS)		\$ 3,490
	912492	INTERFACE BOARD 240V (AM MODELS)		\$ 3,490
	261067	24 VDC REMOTE ON/OFF RELAY (AM MODELS)		\$ 47
	261225	120 VAC REMOTE ON/OFF RELAY (AM MODELS)		\$ 80
	903733	240 VAC REMOTE ON/OFF RELAY (AM MODELS)		\$ 124
	903794	120 VAC REMOTE ON/OFF RELAY (AS/AL MODELS)		\$ 113
	903795	240 VAC REMOTE ON/OFF RELAY (AS/AL MODELS)		\$ 131
	903797	ANALOG OUTPUT MODULE 4-20 mA (AS/AL MODELS)		\$ 1,254
	903804	24 VDC REMOTE ON/OFF RELAY (AS/AL MODELS)		\$ 71
	931071	DECAL, UVP40 CCB WITH KEYPAD		\$ 197
Boards and Controls	43995	CABLE RIBBON 8FT BALLAST TO P40		\$ 71
	42449	P/S 24VDC 4A 85/265VAC		\$ 870
	916399-7524	PS, 24VDC, 3.2A, 76.2W		\$ 337
	913427	Relay Module for wiper, 240V		\$ 162
	18656	CABLE 36 RIBBON 16PIN		\$ 55

After Market Parts

UV Logics Series

Item	Part Number	Description	Picture	List Price (USD)
Fuses	914568-060	FUSE 6A 600V CL CC ATDR		\$ 76
	914569-005	FUSE 0.5A 600V CL CC ATQR		\$ 76
	914568-200	FUSE 20A 600V CL CC ATDR		\$ 76

Manual Wiper Assembly

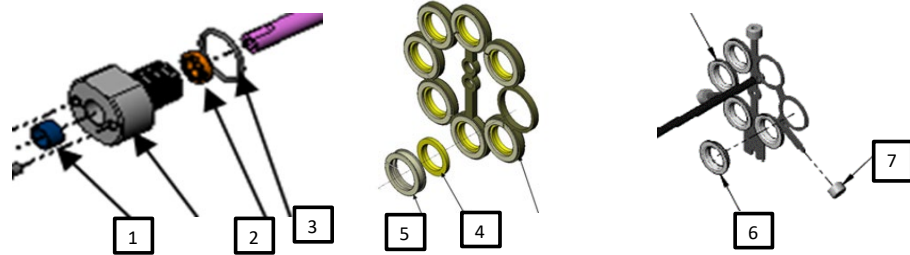

Wiping System	793455	Bushing plain 0.5"ID x0.375 (Item 1)		\$ 27
	794584	Rod seal 0.5" ID Viton FDA (Item 2)		\$ 82
	002190-123F	O-ring 1-3/16 x 3/32 Viton (Item 3)		\$ 14
	794432	Wiper seal Viton (Item 4)		\$ 36
	794917	Wiper holder Teflon (Item 5)		\$ 64
	792942	Bushing sleeve holders 28mm (Item 6)		\$ 67
	792916	Wear pads (Item 7)		\$ 13

After Market Parts

UV Logics Series

Item	Part Number	Description	Picture	List Price (USD)
------	-------------	-------------	---------	------------------

Auto Wiper Assembly

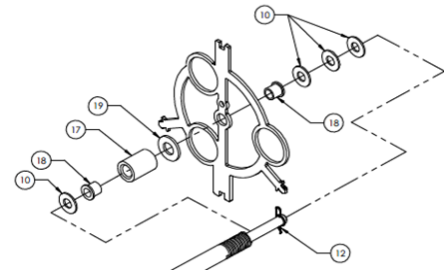
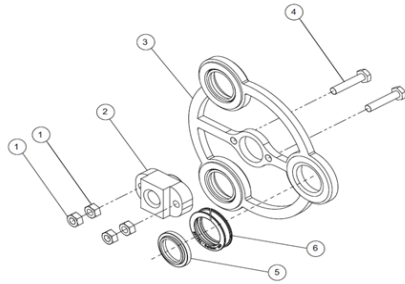

Wiping System

794375 Drive Nut (Item 2)



\$ 372

794432 Wiper seal Viton (Item 5)



\$ 36

794917 Wiper holder Teflon (Item 6)



\$ 64

13029 PIN, COTTER (AUTO) (Item 12)



\$ 9

795819 spring bushing (Item 17) (Replaces 794151)



\$ 134

798123-001 bushing (Item 18) (Replaces 794238)

\$ 186

After Market Parts

UV Logics Series

Item	Part Number	Description	Picture	List Price (USD)
------	-------------	-------------	---------	------------------

Auto Wiper G3 Drive Assembly (double seal)

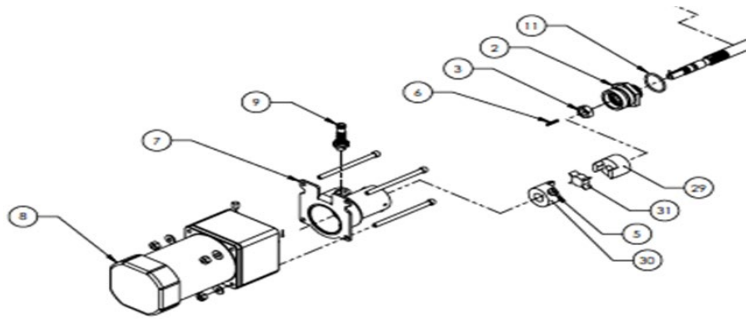

Wiping System

794872	wiper bearing housing kit G3 (Item 2)		\$	2,342
914172-050	Proximity sensor (Item 9)		\$	367
002190-123F	O-ring 1-3/16 x 3/32 Viton (Item 11)		\$	14
794909-001	Jaw coupling- 7/16" id (Item 29)		\$	131
794909-002	Jaw coupling- 5/8" id (Item 30)		\$	164
794909-003	Jaw coupling spider (Item 31)		\$	116
794872	Bearing Housing kit, G2		\$	2,342



After Market Parts

UV Logics Series

Item	Part Number	Description	Picture	List Price (USD)
		Auto Wiper G2 (Single Seal)		
	794455	wiper bearing housing kit G2 (Item1)		\$ 873
	002190-123F	O-ring 1-3/16 x 3/32 Viton (Item 2)		\$ 14
Wiping System	794909-001	Jaw coupling- 7/16" id (Item 3)		\$ 131
	794909-002	Jaw coupling- 5/8" id (Item 3)		\$ 164
	794909-003	Jaw coupling spider (Item 3)		\$ 116
	914172-050	Proximity sensor (Item 4)		\$ 367
	792975	Keyway (Item 5)		\$ 30
	794244	BEARING, BALL 12 MM ID SST		\$ 289





























After Market Parts

UV Logics Series

















Item	Part Number	Description	Picture	List Price (USD)
	794891	Home Limit Switch AssemblyG2		\$ 1,715
	793070-003	Proximity switch with 24 ftcable assembly		\$ 591
Wiping System	11968	NUT COMP L.S.		\$ 52
	820673	SEAL ROD .50 ID VITON-FDA		\$ 72
	303428	O-RING, 1 3/16 I.D., NITRILE (MANUAL & AUTO)		\$ 10
	792868	WASHER, 5/16" ID SST (AUTO)		\$ 10
	792929	O-RING, MANUAL & AUTO #269 - EPDM		\$ 11
	792955	BUSHING, THR 0.5" I.D. BRZ (AUTO)		\$ 29
	792956	BUSHING, THR 0.5" I.D. PLASTIC (AUTO)		\$ 22
	792957	BUSHING, FLG 0.375" I.D. PLASTIC (AUTO)		\$ 22
	793187	SEAL, ROD 0.5" I.D. (MANUAL)		\$ 46
	793096	WASHER, 3/8" I.D. X 9/16 O.D. DELRIN (AUTO)		\$ 16
	793363	WIPER, SLEEVE 28MM (MANUAL & AUTO)		\$ 13
	793686	NUT, DRIVE 5/8-8 ACME (AUTO)		\$ 773

After Market Parts

RBE

Item	Part	Description	Picture	List Price (USD)
Standard Double Ended Lamp				
	3084LM	Disinfection / Ozone destruction 30"		\$ 106
	3098LM	Disinfection / Ozone destruction 60"		\$ 141
	3087	TOC/Chlorine 30"		\$ 129
	3095	TOC/Chlorine 60"		\$ 182
	16676	Validated Disinfection / Ozone destruction 30"		\$ 193
	16677	Validated Disinfection / Ozone destruction 60"		\$ 265
	16678	Validated TOC / Chlorine 30"		\$ 239
UV Lamps	16679	Validated TOC / Chlorine 60"		\$ 340
Standard Single Ended Lamp				
	17491LM	Disinfection / Ozone destruction 30"		\$ 131
	17998LM	Disinfection / Ozone destruction 60"		\$ 170
	18059	Validated Disinfection / Ozone destruction 30"		\$ 204
	18060	Validated Disinfection / Ozone destruction 60"		\$ 277
	18063	TOC / Chlorine 30"		\$ 134
	17498	TOC / Chlorine 60"		\$ 191
	18062	Validated TOC / Chlorine 30"		\$ 253
	18061	Validated TOC / Chlorine 60"		\$ 361
Quartz Sleeves				
	18347	QTZ SLV 22.5mmx30" DE 214		\$ 101
	18348	QTZ SLV 22.5mmx60" DE 214		\$ 150
	3184	QTZ SLV 25mmx30" DE 214		\$ 101
	3198	QTZ SLV 25mmx60" DE 214		\$ 149
Quartz Sleeves O-rings				
	40413	Viton		\$ 12
	4253	EPDM		\$ 11
	12967	Silicon		\$ 11
	16600	Chemraz		\$ 431
Bumper (Spacer)				
	40364	EPDM 22.5mm		\$ 14
	40419	Viton 22.5mm		\$ 13
	4255	EPDM 25mm		\$ 10
	40420	Viton 25mm		\$ 62

After Market Parts
RBE

Item	Part	Description	Picture	List Price (USD)
	40357	Compression Nut Stainless Steel 25mm		\$ 193
	18468	Compression Nut Stainless Steel 22.5mm		\$ 193
	51049	SE Compression Nut Tool		\$ 205
	17489	Compression Nut cap with Hole		\$ 21
	17489-1	Compression Nut cap without hole		\$ 21
Compression Nuts and Lamp Sockets	47520-1	Lamp Socket kit 3ft		\$ 60
	47387-3	Lamp Socket SE 3 ft.		\$ 43
	47597	Wave Spring (Replaces 47518)		\$ 6
	17489-5	Lamp cap with hole (used with lamp socket 47387)		\$ 21
	47520-3	Lamp Socket kit 8ft		\$ 73
	47387-8	Lamp Socket SE 8 ft.		\$ 55
	47597	Wave Spring (Replaces 47518)		\$ 6
	17489-5	Lamp cap with hole (used with lamp socket 47387)		\$ 21
	47520-5	Lamp Socket kit 16ft		\$ 81
	47387-16	Lamp Socket SE 16 ft.		\$ 63
	47597	Wave Spring		\$ 6
	17489-5	Lamp cap with hole (used with lamp socket 47387)		\$ 21

After Market Parts













RBE

Item	Part	Description	Picture	List Price (USD)
	13899	Double Ended (DE) Socket Lok Asy, 5 pcs		\$ 78
	12423	Spring		\$ 11
	12421	Large cap (spring side)		\$ 21
	12420	Small cap		\$ 20
Compression Nuts and Lamp Sockets	12422	DE Compression Nut, CPVC 25mm		\$ 30
	16184-1	DE lamp Socket 8 ft.		\$ 40
	16184	DE lamp Socket 2 ft.		\$ 28
	16898	DE Compression Nut, Stainless steel 25mm		\$ 193
	4252	DE Compression Nut CPVC 25mm		\$ 25
	3105	DE Compression Nut wrench		\$ 99
For Electro Magnetic Ballast retrofit kits reference 'Retrofit Parts' page				
Ballast	16518-3	120/240 V Electronic ballast (Replaces 16518-1)		\$ 278
	16519	5 pin ballast connector assembly		\$ 47
UV Intensity (UVI) Sensor	18176-1	S-254 UV Intensity Sensor (1-12 lamp std / 1-6 HE/HX - 360 DEG)		\$ 1,219
	18176-3	S-254 UV Intensity Sensor (16-36 std lamp / 8-12 HE/HX - 360 DEG)		\$ 1,219
	18176-5	S-254 UV Intensity Sensor (16-36 HE/HX - 360 DEG)		\$ 1,229
	40246	Sensor Window Kit		\$ 393

After Market Parts
RBE



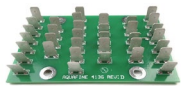



Item	Part	Description	Picture	List Price (USD)
	16571	Top Mount UV Intensity Sensor S-254		\$ 1,382
	48425	X-254 UV/Temperature Hermetically Sealed Detector		\$ 2,322
	4252	Compression nut S-254		\$ 25
	12889	S-254 Port Plug Assembly		\$ 105
	40432	O-ring Viton (Used in 16881, 18176-X)		\$ 14
	16881	O-ring EPDM (Used in 16881, 18176-X)		\$ 10
UV Intensity (UVI) Sensor	13898	Coax cable assembly 5 ft		\$ 62
	14150	Coax cable assembly 15 ft		\$ 77
		16956	PLUG, S-254 SNSR 3/4-16	
	43240-1	Assembly Kit Detector		\$ 1,652
	42601	X-254 Detector		\$ 1,466
	41116	20 ft. Cable for X-254		\$ 213

After Market Parts
RBE













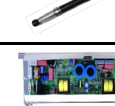

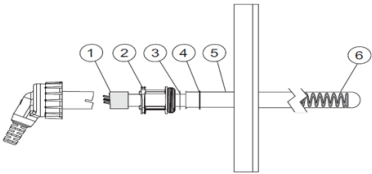

Item	Part	Description	Picture	List Price (USD)
	43240	Assembly Kit Detector with NIST Certificate		\$ 2,506
UV Intensity (UVI) Sensor	43055	NIST Certificate for 42601		\$ 854
	42601	X-254 Detector		\$ 1,466
	41116	20 ft. Cable for X-254		\$ 213
Temperature Sensors (T-120)	792947-1	Surface mount temperature switch only		\$ 100
	16957	Thermistor (requires swagelok)		\$ 350
	19537	swagelok 3/8 NPTx3/16"		\$ 160
	4055	swagelok 1/4 NPTx3/16"		\$ 96
	16958	Thermistor control board (T-120)		\$ 674
	17405	Thermistor retro kit		\$ 987
Boards and Controls	15843	Hour Meter-square 120/60		\$ 148
	15844	Hour Meter-square 240/50		\$ 148
	17745	Hour Meter-square 240/60		\$ 136
	3170	Hour Meter -Round 120/60		\$ 169
	3191	Hour Meter -Round 240/50		\$ 169
	3192	Hour Meter -Round 260/50		\$ 206
	12861	Power Dist Board for T120		\$ 257
	12860	Power Dist Board for no T120		\$ 216
	16460	Lexan (up to 12 lamp)		\$ 28
17896	LED asy (6 lamp std lamp)		\$ 369	
17890	LED asy (12 lamp std lamp)		\$ 441	

After Market Parts

RBE







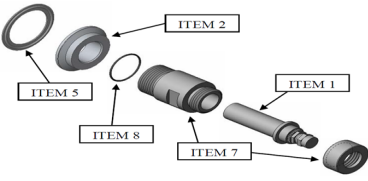

Item	Part	Description	Picture	List Price (USD)
	18907	LED CMPNT asy 12 std lamp 16 pin		\$ 441
	18655	PC ASY 36 LED RBE,SCD		\$ 486
	18656	Ribbon cable for 16 pin		\$ 55
Boards and Controls	43011-3	LOA PC Asy STD 4 lamp 120V		\$ 956
	43011-4	LOA PC Asy STD 6 lamp 120V		\$ 956
	43011-5	LOA PC Asy STD 8 lamp 120V		\$ 956
	43011-7	LOA PC Asy STD 12 lamp 120V		\$ 956
	43011-13	LOA PC Asy STD 10 lamp 240V		\$ 956
	43011-14	LOA PC Asy STD 12 lamp 240V		\$ 956
		19747-4		Meter Assembly S-254 controller(vertical mt) 120V
	19747-10	Meter Assembly S-254 controller (vertical mt) 120V w 4-20mA	\$ 1,314	
	19747-5	Meter Assembly S-254 controller (vertical mt) 240V	\$ 1,098	
	19747-11	Meter Assembly S-254 controller (vertical mt) 240V w 4-20mA	\$ 1,314	
Fan	3901	FAN, 4" 118V/60HZ		\$ 130
	3903	FAN,4"236V 50/60HZ 106CFM		\$ 118
Fuse	14205	FUSE, 3A 600V KTK 10.3x38.1MM		\$ 47
Treatment Chamber Gasket	3118	GASKET, 6" END FLA EPDM		\$ 23
	3244	GASKET, 8" END FLA EPDM		\$ 64
	16673	GASKET,6"END FL VITON FDA		\$ 243
	16674	GASKET,8"END FL VITON FDA		\$ 778
	12131	GASKET,END FLG 6" CYL SILICONE		\$ 179
	12132	GASKET,END FLG 8" CYL SILICONE		\$ 392

After Market Parts
SBV & UVK Marine Series

Item	Part Number	Description	Picture	List Price (USD)
Lamps	794113	Lamp, GA27T6 254nm UVK1000-2000		\$ 375
	793923	Single Lamp, GA40T6 Amalgam UVK3000-8000		\$ 437
	794447-ORD	Single Lamp, GA64T6HE Angle Base SBV300-3000/UVK3000D-30000D		\$ 689
Quartz Sleeves	793024	Sleeve, QTZ 28x25x1570mm SBV300-3000/UVK3000D-30000D		\$ 161
	792934	Sleeve, Quartz 28x25x1016mm UVK2000-8000		\$ 146
	793075	Sleeve, Quartz 28x25x700mm UVK1000		\$ 131
	794316	Sleeve Removal tool, 28mm		\$ 715
Lamp Drivers	917067	Lamp Driver, 2 X 240W 208-277		\$ 1,030
	912513	Ballast Assy, Auto-Ranging		\$ 620
Angle Base Lamp				
Compression Nuts, Quartz Sleeve O-Rings and Lamp Sockets	49680-1	Sleeve bolt, metal (Item 2)		\$ 223
	792931	Cushion washer (Item 3)		\$ 16
	002190-319F	O-ring Viton (Item 4)		\$ 47
	820887-4020	Lamp PWR cable assembly, 20 ft.		\$ 193
	796054	spring (lamp) (Item 6)		\$ 11
	792942	Bushing, Sleeve Holder 28mm		\$ 67
	794486	Spring, AE Lamp Support		\$ 38
	821132	Kit, Sleeve Bolt W/Washer		\$ 55
	795750	Bolt, Sleeve 28MM W/Cap Gen 2		\$ 92
	820887-4022	Lamp PW CA Assy, 4 COND 22'		\$ 231
002190-215FP	O-Ring, 1-1/16 X 1/8 Viton		\$ 20	
901554	Tool, 28mm Sleeve Bolt W/Cap		\$ 522	









After Market Parts

SBV & UVK Marine Series

Item	Part Number	Description	Picture	List Price (USD)
	DVGW Sensor			
	794528	SENSOR, AMALGAM DVGW 40DEG (Item 1)		\$ 2,896
	820693-003	Gasket 2" sanitary (Item 5)		\$ 20
	795807-100	UV Sensor Window Assembly (Locking window) (Item 5)		\$ 1,058
	794530-100	UV sensor Window Assembly (Item 7)		\$ 585
	794611	O-ring 1.257X .063 Viton (Item 8)		\$ 84
	002190-026F	O-ring 1.257X .063 Viton (Item 8)		\$ 14
UV Intensity (UVI) Sensor	013213-200	2" sanitary clamp		\$ 75
	794526	Sensor Assy, SwiftSC 40Deg		\$ 5,231
	52666-02	SENSOR, DIGITAL NO. 2		\$ 4,378
	52666-03	SENSOR, DIGITAL NO. 3		\$ 4,378
	52666-04	SENSOR, DIGITAL NO. 4		\$ 4,378
	52666-05	SENSOR, DIGITAL NO. 5		\$ 4,378
	52666-06	SENSOR, DIGITAL NO. 6		\$ 4,378
	52666-07	SENSOR, DIGITAL NO. 7		\$ 4,378
	52666-08	SENSOR, DIGITAL NO. 8		\$ 4,378
	52666-10	SENSOR, DIGITAL NO. 10		\$ 4,378
	52666-12	SENSOR, DIGITAL NO. 12		\$ 4,378
	52667	Y-CONNECTOR,RS485, M12x1		\$ 490
	52668	CABLE, SNSR RS485, M12x1, 2ft		\$ 387
Temperature Switch	792947	TEMPERATURE SWITCH 120F		\$ 83

After Market Parts





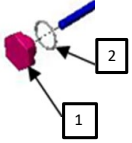
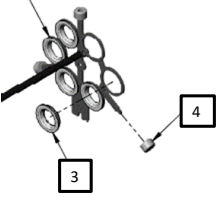

SBV & UVK Marine Series

Item	Part Number	Description	Picture	List Price (USD)
	931066-001	Board, UVLogic P40 CCB 24VDC		\$ 3,318
	931071	DECAL, UVP40 CCB WITH KEYPAD		\$ 197
	931122-001	BOARD,P40 ETHERNET ETHER		\$ 2,069
	931122-002	BOARD, P40 ETHERNET MODBUSTCP		\$ 2,069
	931122-003	BOARD, P40 ETHERNET PROFINET		\$ 2,069
Boards and Controls	931067	4-20Ma ANALOG OUTPUT MODULE, P-40 CONTROL BOARD		\$ 986
	931080-001	BOARD, P40 ETHERNET MODBUS RTU RS485		\$ 542
	913427	Relay Module for wiper, 240V		\$ 162
	43995	CABLE RIBBON 8FT BALLAST TO P40		\$ 71
	916399-7524	PS, 24VDC, 3.2A, 76.2W		\$ 337
	52665-XXXX	SwiftBev HMI, MONITOR, DUV27, 7" TOUCH SCRN Contact Technical Service		\$ 7,725
	912491	Board, UV8AM 120V Midflow		\$ 3,490

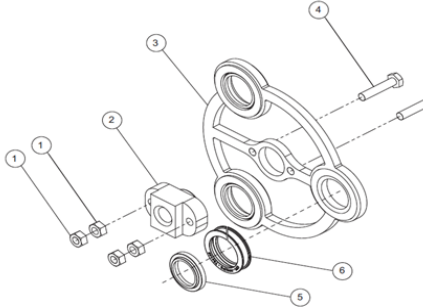
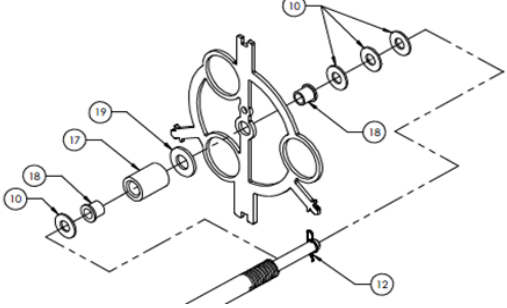
After Market Parts

SBV & UVK Marine Series

Item	Part Number	Description	Picture	List Price (USD)
		Non Wiper Unit	 	
	794225-001	Plug busing non wiper		\$ 446
	002190-123F	O-ring Viton		\$ 14
	792942	Bushing sleeve holders 28mm		\$ 67
	792916	Wear pads		\$ 13

Item	Part Number	Description	Picture	List Price (USD)
		Auto Wiper Assembly	 	
	794375	Drive Nut (Item 2)		\$ 372
	794432	Wiper seal Viton (Item 5)		\$ 36
	794917	Wiper holder Teflon (Item 6)		\$ 64
	13029	PIN, COTTER (AUTO) (Item 12)		\$ 9
	795819	spring bushing (Item 17) (Replaces 794151)		\$ 134
	798123-001	bushing (Item 18) (Replaces 794238)		\$ 186

After Market Parts

SBV & UVK Marine Series

Item	Part Number	Description	Picture	List Price (USD)
		Auto Wiper G3 Drive Assembly (double seal)		
	794872	wiper bearing housing kit G3 (Item 2)		\$ 2,342
Wiping System	914172-050	Proximity sensor (Item 9)		\$ 367
	002190-123F	O-ring 1-3/16 x 3/32 Viton (Item 11)		\$ 14
	794909-001	Jaw coupling- 7/16" id (Item 29)		\$ 131
	794909-002	Jaw coupling- 5/8" id (Item 30)		\$ 164
	794909-003	Jaw coupling spider (Item 31)		\$ 116
	794872	Bearing Housing kit, G2		\$ 2,342
	793070-003	Sensor Assy, Proximity M12 24'		\$ 591
End Plate Gaskets	820693-006	Gasket, Sanitary 6" Viton		\$ 191
	820693-008	Gasket, Sanitary 8" Viton		\$ 240

After Market Parts

UVK1, UVK2, UVK3 and UK4 Series













Model	Part Number	Description	List Price (USD)
UVK-1&2	7305	UV LAMP	\$ 518
UVK-1&2	7318K	UV LAMP WIRE HARNESS W/ COVER FOR THRUST	\$ 639
UVK-1&2	8214	QUARTZ SLEEVE L 933 25MM	\$ 493
UVK-1&2	7311	QUARTZ SLEEVE O-RING	\$ 24
UVK-1&2	90511	PRESSURE PLATE	\$ 193
UVK-1&2	3051A	THRUST COLLAR IMBUS SCREWS DIN 912	\$ 12
UVK-1&2	3051B	IMBUS SCREWS DIN 912 FOR COVER	\$ 12
UVK-1&2	8117K	UV SENSOR W/ CABLE AND PLUG	\$ 851
UVK-1&2	3066	UV SENSOR PLUG - PTFE	\$ 152
UVK-1&2	E0422	DE-AERATION SCREW IMBUS DIN 912	\$ 12
UVK-1&2	E0068A	DE-AERATION SCREW GASKET	\$ 12
UVK-1&2	TA7071	UV CONTROL	\$ 851
UVK-1&2	7072	ELECTRONIC BALLAST	\$ 425
UVK-1&2	E0117	OPERATING HOUR METER 50HZ	\$ 174
UVK-1&2	E0118	OPERATING HOUR METER 60HZ	\$ 174
UVK-1&2	E0040	FUSE WIRE INSERT 2A W/ INDICATOR (F1; F2)	\$ 26
UVK-1&2	E0052	FUSE WIRE INSERT 2A W/ INDICATOR (F3; F4)	\$ 21
UVK-3	8137S	UV LAMP	\$ 842
UVK-3	8122K	UV LAMP WIRE HARNESS W/COVER	\$ 551
UVK-3	8214	QUARTZ SLEEVE	\$ 493
UVK-3	7311	QUARTZ SLEEVE O-RING	\$ 24
UVK-3	90511	PRESSURE PLATE	\$ 193
UVK-3	3051A	THRUST COLLAR IMBUS SCREWS DIN 912	\$ 12
UVK-3	3051B	THRUST COLLAR COVER IMBUS SCREWS DIN 912	\$ 12
UVK-3	8117	SNSR ASSY 2.5M L RMT UVK	\$ 273
UVK-3	8117K	UV SENSOR W/ CABLE AND PLUG	\$ 851
UVK-3	3066	UV SENSOR PLUG, PTFE	\$ 152

After Market Parts**UVK1, UVK2, UVK3 and UK4 Series**

Model	Part Number	Description	List Price (USD)	
UVK-3	E0068A	DE-AERATION SCREW GASKET	\$	12
UVK-3	TA7071	UV CONTROL 7071	\$	851
UVK-3	8123	BALLAST OMB140	\$	395
UVK-3	8129	ELECTRONIC IGNITOR ZRM12	\$	162
UVK-3	E0466	START-UP RELAY	\$	395
UVK-3	E0117	OPERATING HOUR METER 50HZ	\$	174
UVK-3	E0118	OPERATING HOUR METER 60HZ	\$	174
UVK-3	E0039	FUSE WIRE INSERT 4A 5X25 W/ INDICATOR (F1; F2)	\$	22
UVK-3	E0040	FUSE WIRE INSERT 2A 5X25 W/ INDICATOR (F1; F2)	\$	26
UVK-3	E0052	FUSE WIRE INSERT 2A 5X25 W/ INDICATOR (F3; F4)	\$	21
UVK-4	8138S4H	UV LAMP	\$	877
UVK-4	81224K	UV LAMP CABLE	\$	436
UVK-4	3056	QUARTZ SLEEVE	\$	700
UVK-4	E0410	QUARTZ SLEEVE O-RING	\$	20
UVK-4	90541	PRESSURE PLATE	\$	282
UVK-4	90542	THRUST COLLAR COVER	\$	405
UVK-4	8200D	IMBUS SCREWS M5X16 DIN 912	\$	13
UVK-4	3053A	IMBUS M5X12 DIN 912	\$	13
UVK-4	8117	SNSR ASSY 2.5M L RMT UVK	\$	273
UVK-4	8117K	UV SENSOR W/CABLE & PLUG	\$	850
UVK-4	3066	UV SENSOR PLUG, PTFE	\$	152
UVK-4	7099	ELECTRONIC BALLAST	\$	1,678
UVK-4	TA7071	UV CONTROL	\$	851
UVK-4	7072	ELECTRONIC BALLAST	\$	425
UVK-4	E0039	FUSE WIRE INSERT 4A 5X25 W/ INDICATOR (F1; F2)	\$	22
UVK-4	E0040	FUSE WIRE INSERT 2A 5X25 W/ INDICATOR (F4)	\$	26
UVK-4	E0052	FUSE WIRE INSERT 1A 5X25	\$	21
UVK-4	E0117	OPERATING HOUR METER 50HZ	\$	174
UVK-4	E0118	OPERATING HOUR METER 60HZ	\$	174

After Market Parts

SP and SL10A Series

Model	Part Number	Description		List Price (USD)
SP-1	3010	LAMP DE		\$ 46
SP-1	3318	LAMP DRIVER, 120V/60HZ		\$ 37
SP-1	4131	LAMP DRIVER, 236V/50HZ		\$ 78
SP-1	3317	STARTER LAMP, FS 5		\$ 30
SP-1	3110	QUARTZ SLEEVE DE (22.5MM) 10"		\$ 76
SP-1	4252	COMPRESSION NUT		\$ 25
SP-1	3583	BUSH QUARTZ CPRSN SP CPVC		\$ 49
SP-1	3324	LAMP SOCKET MINI BI PIN		\$ 15
SP-1	4253	QUARTZ SLEEVE O-RING - EPDM		\$ 11
SP-1	16458	QUARTZ SLEEVE O-RING, BLACK - VITON®		\$ 11
SP-1	40413	QUARTZ SLEEVE O-RING, RED - VITON®		\$ 12
SP-1	16709	PORT, VIEW 3/8" ACRYLIC		\$ 37
SP-2	3011	LAMP DE		\$ 80
SP-2	4157	STARTER LAMP		\$ 30
SP-2	51088	BALLAST, 120V/60HZ		\$ 61
SP-2	52205	BALLAST 120/240 50/60 Hz		\$ 148
SP-2	3110	QUARTZ SLEEVE DE (22.5MM) 10"		\$ 76
SP-2	4252	COMPRESSION NUT		\$ 25
SP-2	3324	LAMP SOCKET MINI BI PIN		\$ 15
SP-2	4253	QUARTZ SLEEVE O-RING - EPDM		\$ 11
SP-2	40413	QUARTZ SLEEVE O-RING, RED - VITON®		\$ 12
SP-2	18904	GROMMET,RUBBER.68X.078X1		\$ 8
SL-10A	3050	STANDARD SE LAMP (254NM) MAUVE 15"		\$ 80
SL-10A	16714	VALIDATED SE LAMP (254NM) GREEN 15"		\$ 176
SL-10A	3052	STANDARD SE LAMP (185NM) BLUE 15"		\$ 82
SL-10A	16715	VALIDATED SE LAMP (185NM) YELLOW 15"		\$ 170
SL-10A	3150	QUARTZ SLEEVE DE (25MM) 15"		\$ 67
SL-10A	12421	COMPRESSION NUT CAP - SPRING LOADED		\$ 21
SL-10A	12423	SPRING		\$ 11
SL-10A	12420	FIXED COMPRESSION NUT CAP		\$ 20
SL-10A	3105	COMPRESSION NUT TOOL		\$ 99
SL-10A	16184	LAMP SOCKET DE		\$ 28
SL-10A	4253	QUARTZ SLEEVE O-RING - EPDM		\$ 11
SL-10A	40413	QUARTZ SLEEVE O-RING, RED - VITON®		\$ 12
SL-10A	12967	QUARTZ SLEEVE O-RING - SILICONE		\$ 11

After Market Parts

UV Lamps

Part Number	Technology	Validated	Design	Length	Application	Pack	List Price (USD)
Gold-M	HX	No	SE	13"	Disinfection / Ozone	Single Lamp	\$ 115
Gold-S	HX	No	SE	30"	Disinfection / Ozone	Single Lamp	\$ 156
Gold-S4	HX	No	SE	30"	Disinfection / Ozone	4-pack	\$ 578
Gold-S32	HX	No	SE	30"	Disinfection / Ozone	32-pack	\$ 4,508
Gold-L	HX	No	SE	60"	Disinfection / Ozone	Single Lamp	\$ 232
Gold-L4	HX	No	SE	60"	Disinfection / Ozone	4-pack	\$ 870
Gold-L32	HX	No	SE	60"	Disinfection / Ozone	32-pack	\$ 6,814
Cream-M	HX	Yes	SE	13"	Disinfection / Ozone	Single Lamp	\$ 216
Cream-S	HX	Yes	SE	30"	Disinfection / Ozone	Single Lamp	\$ 248
Cream-L	HX	Yes	SE	60"	Disinfection / Ozone	Single Lamp	\$ 326
Silver-M	HX	No	SE	15"	TOC / Chlorine	Single Lamp	\$ 164
Silver-S	HX	No	SE	30"	TOC / Chlorine	Single Lamp	\$ 200
Silver-L	HX	No	SE	60"	TOC / Chlorine	Single Lamp	\$ 266
Silver-L4	HX	No	SE	60"	TOC / Chlorine	4-pack	\$ 997
Silver-L32	HX	No	SE	60"	TOC / Chlorine	32-pack	\$ 7,826
Tan-S	HX	Yes	SE	30"	TOC / Chlorine	Single Lamp	\$ 295
Tan-L	HX	Yes	SE	60"	TOC / Chlorine	Single Lamp	\$ 354
17491LM	Std	No	SE	30"	Disinfection / Ozone	Single Lamp	\$ 131
17491LM-4	Std	No	SE	30"	Disinfection / Ozone	4-pack	\$ 486
17491LM-32	Std	No	SE	30"	Disinfection / Ozone	32-pack	\$ 3,529
17998LM	Std	No	SE	60"	Disinfection / Ozone	Single Lamp	\$ 170
17998LM-4	Std	No	SE	60"	Disinfection / Ozone	4-pack	\$ 634
17998LM-32	Std	No	SE	60"	Disinfection / Ozone	32-pack	\$ 4,682
18059	Std	Yes	SE	30"	Disinfection / Ozone	Single Lamp	\$ 204
18060	Std	Yes	SE	60"	Disinfection / Ozone	Single Lamp	\$ 277
18063	Std	No	SE	30"	TOC / Chlorine	Single Lamp	\$ 134
18063-4	Std	No	SE	30"	TOC / Chlorine	4-pack	\$ 508
18063-32	Std	No	SE	30"	TOC / Chlorine	32-pack	\$ 3,250
17498	Std	No	SE	60"	TOC / Chlorine	Single Lamp	\$ 191
17498-4	Std	No	SE	60"	TOC / Chlorine	4-pack	\$ 726
17498-32	Std	No	SE	60"	TOC / Chlorine	32-pack	\$ 4,508
18062	Std	Yes	SE	30"	TOC / Chlorine	Single Lamp	\$ 253
18061	Std	Yes	SE	60"	TOC / Chlorine	Single Lamp	\$ 361

After Market Parts

UV Lamps

Part Number	Technology	Validated	Design	Length	Application	Pack	List Price (USD)
3084LM	Std	No	DE	30"	Disinfection / Ozone	Single Lamp	\$ 106
3084LM-4	Std	No	DE	30"	Disinfection / Ozone	4-pack	\$ 389
3084LM-32	Std	No	DE	30"	Disinfection / Ozone	32-pack	\$ 2,726
3098LM	Std	No	DE	60"	Disinfection / Ozone	Single Lamp	\$ 141
3098LM-4	Std	No	DE	60"	Disinfection / Ozone	4-pack	\$ 534
3098LM-32	Std	No	DE	60"	Disinfection / Ozone	32-pack	\$ 3,774
3087	Std	No	DE	30"	TOC / Chlorine	Single Lamp	\$ 129
3087-4	Std	No	DE	30"	TOC / Chlorine	4-pack	\$ 481
3087-32	Std	No	DE	30"	TOC / Chlorine	32-pack	\$ 3,110
3095	Std	No	DE	60"	TOC / Chlorine	Single Lamp	\$ 182
3095-4	Std	No	DE	60"	TOC / Chlorine	4-pack	\$ 687
3095-32	Std	No	DE	60"	TOC / Chlorine	32-pack	\$ 4,298
16676	Std	Yes	DE	30"	Disinfection / Ozone	Single Lamp	\$ 193
16677	Std	Yes	DE	60"	Disinfection / Ozone	Single Lamp	\$ 265
16678	Std	Yes	DE	30"	TOC / Chlorine	Single Lamp	\$ 239
16679	Std	Yes	DE	60"	TOC / Chlorine	Single Lamp	\$ 340
3015	Std	No	DE	12"	TOC / Chlorine	Single Lamp	\$ 107
3052	Std	No	DE	15"	TOC / Chlorine	Single Lamp	\$ 82
16715	Std	Yes	DE	15"	TOC / Chlorine	Single Lamp	\$ 170
3011	Std	No	DE	12"	Disinfection / Ozone	Single Lamp	\$ 80
3050	Std	No	DE	15"	Disinfection / Ozone	Single Lamp	\$ 80
16714	Std	No	DE	15"	Disinfection / Ozone	Single Lamp	\$ 176
18197	HE	No	SE	30"	TOC / Chlorine	Single Lamp	\$ 255
17820-64	HE	No	SE	60"	TOC / Chlorine	(Bulk +64)	\$ 219
18198-64	HE	No	SE	30"	Disinfection / Ozone	(Bulk +64)	\$ 192
18024-64	HE	No	SE	60"	Disinfection / Ozone	(Bulk +64)	\$ 208
18952	HE	Yes	SE	30"	TOC / Chlorine	Single Lamp	\$ 342
18953	HE	Yes	SE	60"	TOC / Chlorine	Single Lamp	\$ 342
18950	HE	Yes	SE	30"	Disinfection / Ozone	Single Lamp	\$ 293
18951	HE	Yes	SE	60"	Disinfection / Ozone	Single Lamp	\$ 338

After Market Parts

Retrofit Kits for Magnetic Ballast

CSL Upgrade Kit

Model No	Magnetic 120V Ballast Obsoleted	120V Kit Part Number	List Price (USD)	Magnetic 240V Ballast Obsoleted	240V Kit Part Number	240V Kit List Price
CSL 4R	3354	17333	\$ 1,170	4125	17333-1	\$ 1,170
CSL 6R	3354	17334	\$ 1,509	4125	17334-1	\$ 1,509
CSL 8R	3354	17335	\$ 1,848	4125	17335-1	\$ 1,848
CSL 12R	3354	17337	\$ 2,526	4125	17337-1	\$ 2,526
CSL 8R/60	3354	17335	\$ 1,848	4125	17335-1	\$ 1,848
CSL 10R/60	3354	17336	\$ 2,187	4125	17336-1	\$ 2,187
CSL 12R/60	3354	17337	\$ 2,526	4125	17337-1	\$ 2,526
CSL 24R	3354	17659	\$ 5,015	4125	17659-1	\$ 5,015
CSL 16R/60	3354	17660	\$ 3,659	4125	17660-1	\$ 3,659
CSL 20R/60	3354	17661	\$ 4,336	4125	17661-1	\$ 4,336
CSL 24R/60	3354	17659	\$ 5,015	4125	17659-1	\$ 5,015

RBE Upgrade Kit

Model No	Magnetic 120V Ballast - Obsoleted	120V Kit Part Number	120V Kit List Price	Magnetic 240V Ballast - Obsoleted	240V Kit Part Number	240V Kit List Price
RBE 4R	3354	17328	\$ 1,329	4125	17328-1	\$ 1,329
RBE 6R	3354	17329	\$ 1,696	4125	17329-1	\$ 1,696
RBE 8R	3354	17330	\$ 2,033	4125	17330-1	\$ 2,033
RBE 12R	3354	17332	\$ 2,738	4125	17332-1	\$ 2,738
RBE 8R/60	3354	17330	\$ 2,033	4125	17330-1	\$ 2,033
RBE 10R/60	3354	17331	\$ 2,394	4125	17331-1	\$ 2,394
RBE 12R/60	3354	17332	\$ 2,738	4125	17332-1	\$ 2,738
RBE 24R	3354	16719	\$ 5,437	4125	16719-1	\$ 5,437
RBE 16R/60	3354	16720	\$ 4,023	4125	16720-1	\$ 4,023
RBE 20R/60	3354	16721	\$ 4,725	4125	16721-1	\$ 4,725
RBE 24R/60	3354	16719	\$ 5,437	4125	16719-1	\$ 5,437

SCD Upgrade Kit

Model No	Magnetic 120V Ballast - Obsoleted	120V Kit Part Number	120V Kit List Price	Magnetic 240V Ballast - Obsoleted	240V Kit Part Number	240V Kit List Price
SCD 600	3354	18206	\$ 3,104	4125	18206-1	\$ 3,104
SCD 700	3354	18207	\$ 3,800	4125	18207-1	\$ 3,800
SCD 1000	3354	18208	\$ 4,477	4125	18208-1	\$ 4,477
SCD 1200	3354	16718	\$ 6,675	4125	16718-1	\$ 6,675

Small Units Upgrade Kit

Model No	Magnetic 120V Ballast - Obsoleted	120V Kit Part Number	120V Kit List Price	Magnetic 240V Ballast - Obsoleted	240V Kit Part Number	240V Kit List Price
SP-1	3318	52405-1	\$ 414	4131	52405-1	\$ 414
SP-2	3910	52405-2	\$ 304	4134	52405-2	\$ 304
DW-5	18855	52349	\$ 230	40447	52349	\$ 230
DW-8	4035	52363	\$ 230	3493	52363	\$ 230
SL-1	4035	52332	\$ 333	3493	52332	\$ 333
SL-10A	4035	52397	\$ 230	3493	52397	\$ 230
MP-2-SL	3354	18514	\$ 474	4125	18514-1	\$ 474